

APEX SURVEYS

www.apexsurveys.ie
info@apexsurveys.ie
00353 1 691 0156

RURAL/NATURAL FEATURES :

- BUSH
- SAPLING
- TREE
- HEDGE
- TROUGH
- CATTLE GRID

LINework:

- EMBANKMENT TOP
- DRAIN
- BREAKLINE
- BUILDING
- KERB BOTTOM
- WALL
- PATH/CHANGE SURFACE
- O/H EAD ELECTRICITY
- O/H EAD TELECOM

STREET FURNITURE :

- BOLLARDS
- SORE HOLE
- BUS STOP
- CRASH BARRIER
- ELECTRICITY POLE
- EARTHING ROD
- GATE
- GROUND LIGHT
- ILLUMINATED BOLLARD
- LAMP POST
- MARKER POST
- POST
- POST BOX
- POST BOX +
- ROADSIGN
- ROADSIGN
- SIGN POST
- SEPTIC TANK
- TELEPHONE POLE
- TRAFFIC LIGHT
- TRIAL PIT

SERVICES :

- AIR VALVE
- ARMSTRONG JUNCTION
- CABLE TV IC
- COVER LEVEL
- EIRCOM COVER
- EIRCOM JUNCTION BOX
- ELECTRICAL CABLE PIT
- ESAT COVER
- ESB COVER
- ESB JUNCTION BOX
- FIRE HYDRANT
- GAS VALVE
- GULLY
- INSPECTION COVER
- MANHOLE
- SEPTIC TANK
- SLUCE VALVE
- STOPCOCK

SERVICES :

- AV+
- CL
- EIRCOM
- EIRCOM BOX
- ESAT
- ESB
- ESB BOX
- FH+
- GV
- IC
- SEPTIC
- SV
- ST

SERVICES :

- SERVICE BOX (UNKNOWN)
- TRAFFIC COVER
- VENT
- WATER METER
- UNABLE TO LIFT

SERVICES :

- BOX
- TLIC
- VENT
- WM+
- UTO

LEVELS :

- BED LEVEL
- EAVE LEVEL
- FLOOR LEVEL
- INVERT LEVEL
- ROAD LEVEL
- RIDGE LEVEL
- SOFFIT LEVEL
- SPOT LEVEL
- TOP OF FENCE LEVEL
- TOP OF WALL LEVEL
- WATER LEVEL
- SURVEY CONTROL STATION

SHEET LAYOUT :

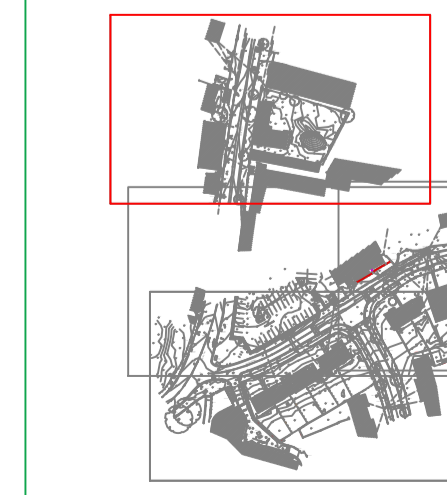

PLAN PRODUCED BY:
APEX SURVEYS

CONTACT INFORMATION:
Apex Surveys
Unit 78 Dunboyme Business Park
Dunboyme, Co. Meath, Ireland
www.apexsurveys.ie
info@apexsurveys.ie
00353 1 691 0156

CLIENT:
Fingal County Council

GRID SYSTEM: Irish Transverse Mercator
DATUM: Malin Head (OSGM15)
NOTES: Drawing Contains Scale Factor

REVISIONS:	
No.	Description
001	N/A Original Drawing
002	27/06/22 Adding Missing Ridge on the North
003	04/07/22 Additional Information Added
004	27/07/22 Additional Information Added

PROJECT:
Seatown Road and North Street, Swords

SCALE :	1/200 A1	DATE :	27/07/2022
DRG No:	5176	DESCRIPTION :	2D Topographical
SHEET:	1 of 4	SURVEYED BY :	Jason Pringle
		PROCESSED BY :	G.M.&D.B.
		CHECKED BY :	Alan Brady

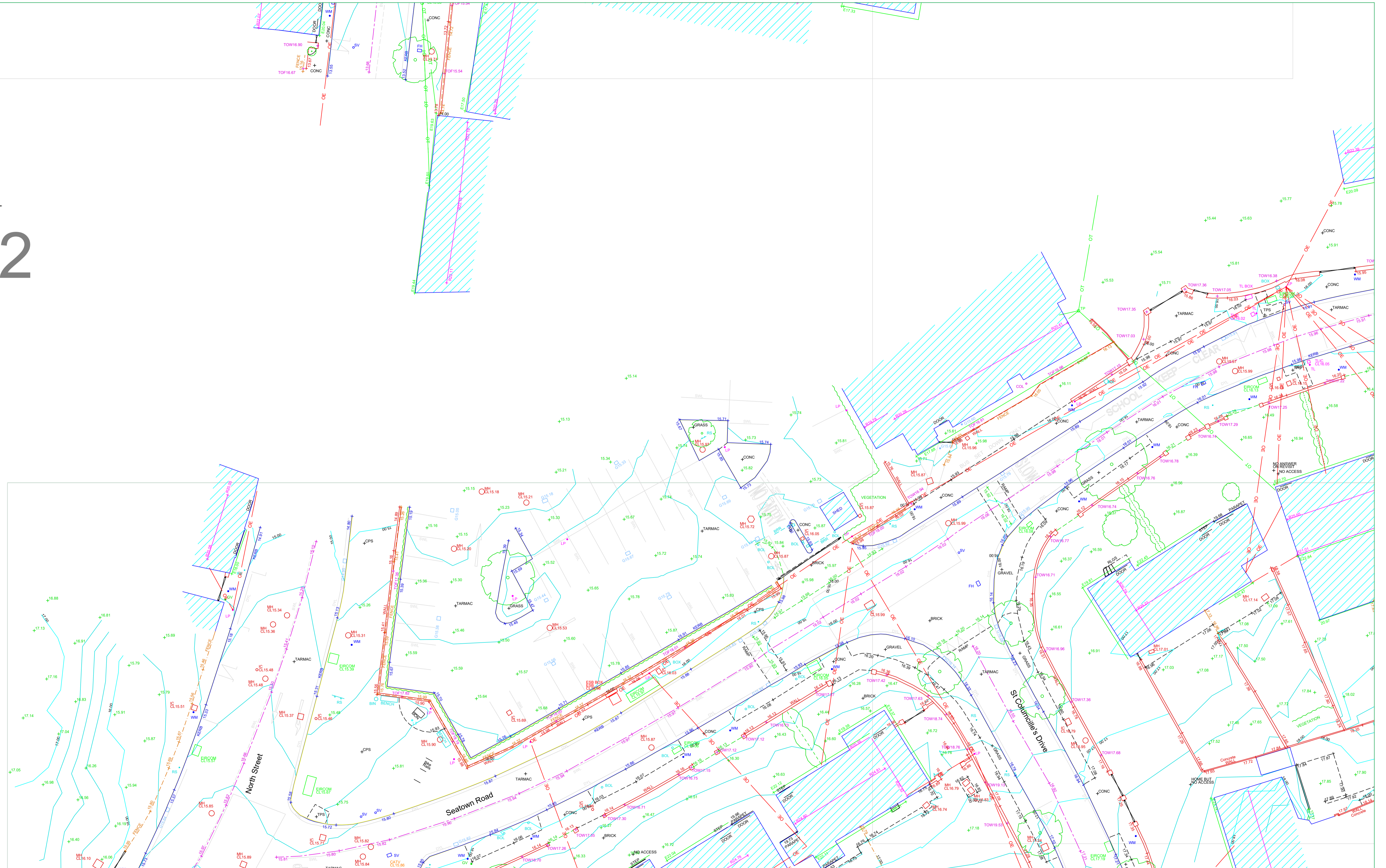
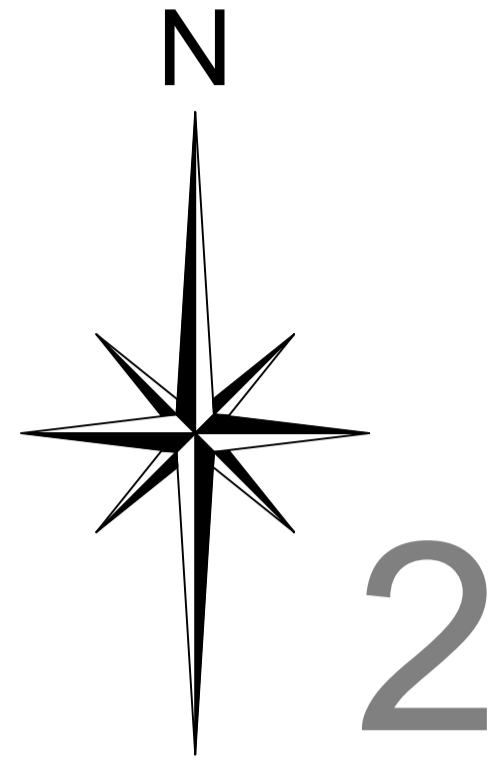

APEX SURVEYS

www.apexsurveys.ie
 info@apexsurveys.ie
 00353 1 691 0156

RURAL/NATURAL FEATURES :

- BUSH
- SAPLING
- TREE
- HEDGE
- TROUGH
- CATTLE GRID
- LINEWORK:**
- EMBANKMENT TOP
- GRAIN
- BREAKLINE
- BUILDING
- KERB BOTTOM
- WALL
- PATH/CHANGE SURFACE
- O/H HEAD ELECTRICITY
- O/H HEAD TELECOM

STREET FURNITURE :

- BOLLARDS
- SORE HOLE
- BUS STOP
- CRASH BARRIER
- ELECTRICITY POLE
- EARTHING ROD
- GATE
- GROUND LIGHT
- ILLUMINATED BOLLARD
- LAMP POST
- MARKER POST
- POST
- POST BOX
- ROADSIGN
- SIGN POST
- TELEPHONE BOX
- TELEPHONE POLE
- TRIAL PIT

SERVICES :

- AIR VALVE
- ARMSTRONG JUNCTION
- CABLE TV IC
- COVER LEVEL
- EIRCOM COVER
- EIRCOM JUNCTION BOX
- ELECTRICAL CABLE PIT
- ESAT COVER
- ESB COVER
- ESB JUNCTION BOX
- FIRE HYDRANT
- GAS VALVE
- GULLY
- INSPECTION COVER
- MANHOLE
- SEPTIC TANK
- SLUICE VALVE
- STOPOCK

SERVICES :

- AV+ (AIR VALVE)
- CL (COVER LEVEL)
- CL (CABLE TV IC)
- CL (EIRCOM COVER)
- CL (EIRCOM JUNCTION BOX)
- ECP (ELECTRICAL CABLE PIT)
- ESAT (ESAT COVER)
- ESB (ESB COVER)
- ESB (ESB JUNCTION BOX)
- FH (FIRE HYDRANT)
- GV (GAS VALVE)
- G (GULLY)
- IC (INSPECTION COVER)
- MH (MANHOLE)
- ST (SEPTIC TANK)
- SV (SLUICE VALVE)
- ST (STOPOCK)

SERVICES :

- BOX (SERVICE BOX (UNKNOWN))
- TLIC (TRAFFIC COVER)
- VENT (VENT)
- WM+ (WATER METER)
- UTO (UNABLE TO LIFT)

LEVELS :

- +BED (BED LEVEL)
- +E101.50 (EAVE LEVEL)
- +FL101.50 (FLOOR LEVEL)
- +I101.50 (INVERT LEVEL)
- +R101.50 (ROAD LEVEL)
- +R101.50 (RIDGE LEVEL)
- +SL101.50 (SOFFIT LEVEL)
- +SP101.50 (SPOT LEVEL)
- +TOP101.50 (TOP OF FENCE LEVEL)
- +TOP101.50 (TOP OF WALL LEVEL)
- +WL101.50 (WATER LEVEL)
- SCS (SURVEY CONTROL STATION)

SHEET LAYOUT :

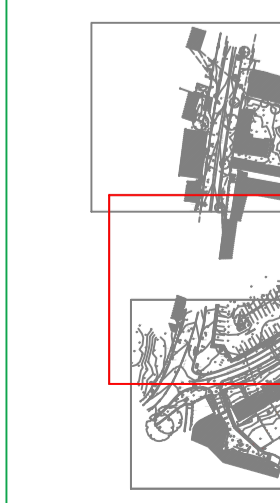

PLAN PRODUCED BY:

APEX SURVEYS

CONTACT INFORMATION:

Apex Surveys
 Unit 78 Dunboyne Business Park
 Dunboyne, Co. Meath, Ireland
 www.apexsurveys.ie
 info@apexsurveys.ie
 00353 1 691 0156

CLIENT:

Fingal County Council

PROJECT:

Seatown Road and North Street, Swords

GRID SYSTEM: Irish Transverse Mercator
 DATUM: Malin Head (OSGM15)
 NOTES: Drawing Contains Scale Factor

No.	Date	Description
001	N/A	Original Drawing
002	27/06/22	Adding Missing Ridge on the North
003	04/07/22	Additional Information Added
004	27/07/22	Additional Information Added

SCALE : 1/200 A1

DRG No: 5176

SHEET: 2 of 4

DATE : 27/07/2022

DESCRIPTION : 2D Topographical

SURVEYED BY : Jason Pringle

PROCESSED BY : G.M.&D.B.
 CHECKED BY : Alan Brady

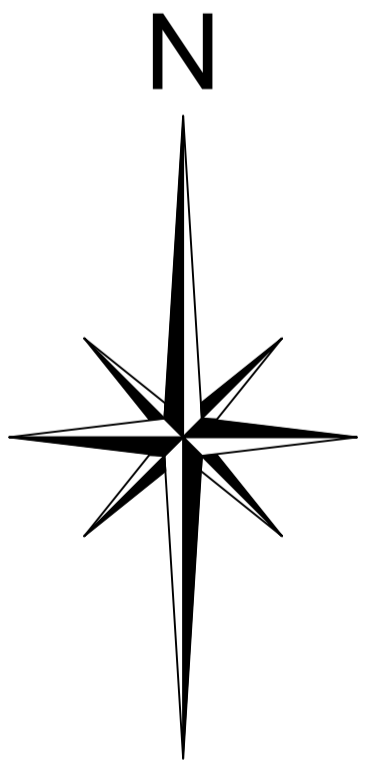
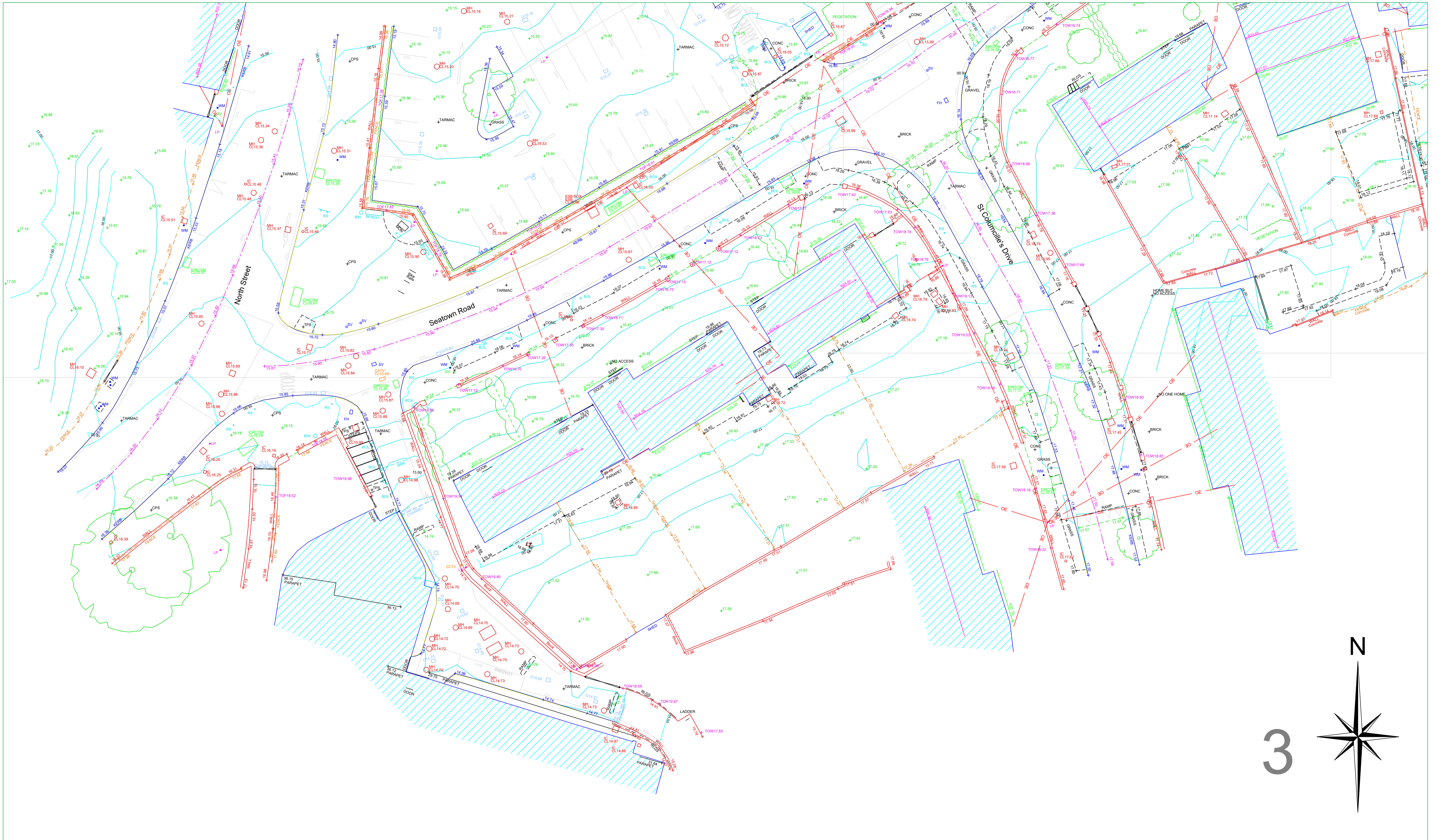

3

APEX SURVEYS

www.apexsurveys.ie
info@apexsurveys.ie
00353 1 691 0156

RURAL/NATURAL FEATURES :

- BUSH
- SAPLING
- TREE
- HEDGE
- TROUGH
- CATTLE GRID
- LINework:**
- EMBANKMENT TOP
- DRAIN
- BREAKLINE
- BUILDING
- KERB BOTTOM
- WALL
- PATH/CHANGE SURFACE
- OHEAD ELECTRICITY
- OHEAD TELECOM

STREET FURNITURE :

- BOLLARDS
- BORER HOLE
- BUS STOP
- CRASH BARRIER
- ELECTRICITY POLE
- EARTHING ROD
- GATE
- GROUND LIGHT
- ILLUMINATED BOLLARD
- LAMP POST
- MARKER POST
- POST
- POST BOX
- ROADSIGN
- SIGN POST
- TELEPHONE BOX
- TELEPHONE POLE
- TRIAL PIT

SERVICES :

- AIR VALVE
- ARMSTRONGS JUNCTION
- CABLE TV IC
- COVER LEVEL
- EIRCOM COVER
- EIRCOM JUNCTION BOX
- ELECTRICAL CABLE PIT
- ESAT COVER
- ESB COVER
- ESB JUNCTION BOX
- FIRE HYDRANT
- GAS VALVE
- GULLY
- INSPECTION COVER
- MANHOLE
- SEPTIC TANK
- SLUICE VALVE
- STOPCOCK

SERVICES :

- SERVICE BOX (UNKNOWN)
- TRAFFIC COVER
- VENT
- WATER METER
- UNABLE TO LIFT
- LEVELS :**
- BED LEVEL
- EAVE LEVEL
- FLOOR LEVEL
- INVERT LEVEL
- ROAD LEVEL
- RIDGE LEVEL
- SOFFIT LEVEL
- SPOT LEVEL
- TOP OF FENCE LEVEL
- TOP OF WALL LEVEL
- WATER LEVEL
- SURVEY CONTROL STATION

SHEET LAYOUT :

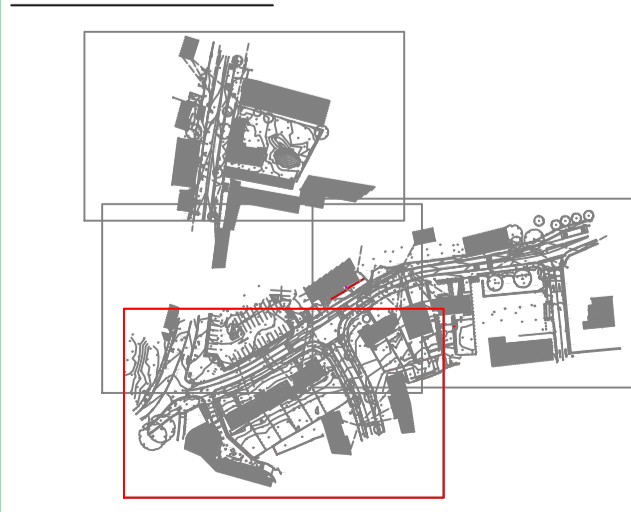

PLAN PRODUCED BY:

APEX SURVEYS

CONTACT INFORMATION:

Apex Surveys
Unit 78 Dunboyne Business Park
Dunboyne, Co. Meath, Ireland
www.apexsurveys.ie
info@apexsurveys.ie
00353 1 691 0156

CLIENT:

Fingal County Council

PROJECT:

Seatown Road and North Street, Swords

GRID SYSTEM: Irish Transverse Mercator
DATUM: Malin Head (OSGM15)
NOTES: Drawing Contains Scale Factor

REVISIONS:

No.	Date	Description
001	N/A	Original Drawing
002	27/06/22	Adding Missing Ridge on the North
003	04/07/22	Additional Information Added
004	27/07/22	Additional Information Added

SCALE : 1/200 A1

DRG No: 5176

SHEET: 3 of 4

DATE : 27/07/2022

DESCRIPTION : 2D Topographical

SURVEYED BY : Jason Pringle

PROCESSED BY : G.M.&B.

CHECKED BY : Alan Brady

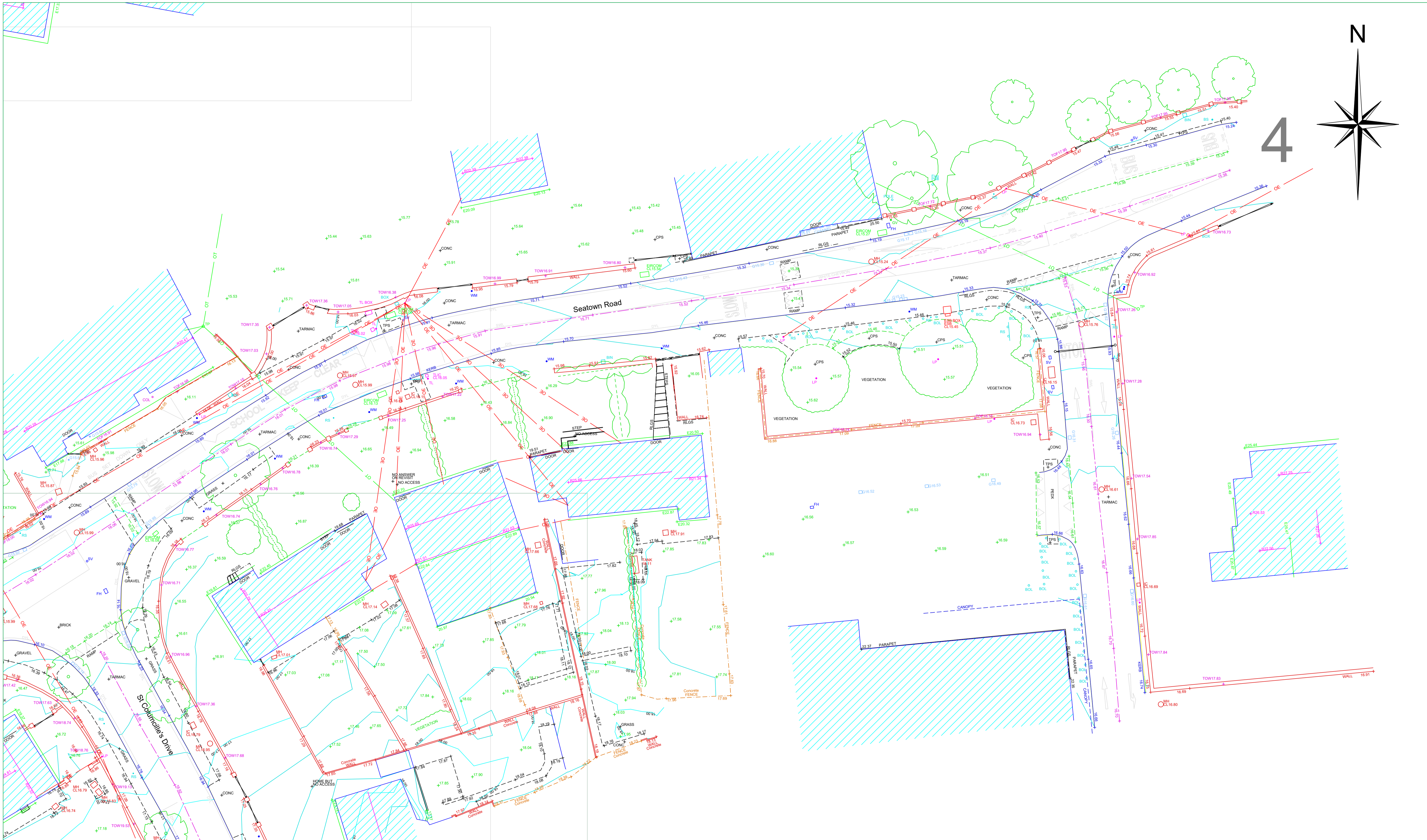

APEX SURVEYS

www.apexsurveys.ie
 info@apexsurveys.ie
 00353 1 691 0156

RURAL/NATURAL FEATURES :

- BUSH
- SAPLING
- TREE
- HEDGE
- TROUGH
- CATTLE GRID
- GATE
- EMBANKMENT TOP
- DRAIN
- BREAKLINE
- BUILDING
- KERB BOTTOM
- WALL
- PATH/CHANGE SURFACE
- O/H HEAD ELECTRICITY
- O/H HEAD TELECOM

STREET FURNITURE :

- BOLLARDS
- BORE HOLE
- BUS STOP
- CRASH BARRIER
- ELECTRICITY POLE
- EARTHING ROD
- GATE
- GROUND LIGHT
- ILLUMINATED BOLLARD
- LAMP POST
- MARKER POST
- POST
- POST BOX
- ROADSIGN
- SIGN POST
- TELEPHONE BOX
- TELEPHONE POLE
- TRAFFIC LIGHT
- TRIAL PIT

SERVICES :

- AIR VALVE
- ARMSTRONG JUNCTION
- CABLE TV IC
- COVER LEVEL
- EIRCOM COVER
- EIRCOM JUNCTION BOX
- ELECTRICAL CABLE PIT
- ESAT COVER
- ESB COVER
- ESB JUNCTION BOX
- FIRE HYDRANT
- GULLY
- INSPECTION COVER
- MANHOLE
- SEPTIC TANK
- SLUICE VALVE
- STOPCOCK

SERVICES :

- AV+ (AIR VALVE)
- BS+ (BORE HOLE)
- CB (CRASH BARRIER)
- EP+ (ELECTRICITY POLE)
- ER+ (EARTHING ROD)
- LP+ (LAMP POST)
- MRK (MARKER POST)
- POST (POST)
- RS+ (ROADSIGN)
- SGN (SIGN POST)
- TB (TELEPHONE BOX)
- TP+ (TELEPHONE POLE)
- TL+ (TRAFFIC LIGHT)
- TPIT+ (TRIAL PIT)

SERVICES :

- BOX (SERVICE BOX (UNKNOWN))
- CL (TRAFFIC COVER)
- CLV (VENT)
- WM+ (WATER METER)
- UTO (UNABLE TO LIFT)

- LEVELS :**
- BED LEVEL +BED101.50
 - EAVE LEVEL +E101.50
 - FLOOR LEVEL +FL101.50
 - INVERT LEVEL +I101.50
 - ROAD LEVEL +R101.50
 - RIDGE LEVEL +SL101.50
 - SOFFIT LEVEL +S101.50
 - SPOT LEVEL +TOW101.50
 - TOP OF FENCE LEVEL +TOP101.50
 - TOP OF WALL LEVEL +TW101.50
 - WATER LEVEL +WL101.50
 - SURVEY CONTROL STATION

SHEET LAYOUT :

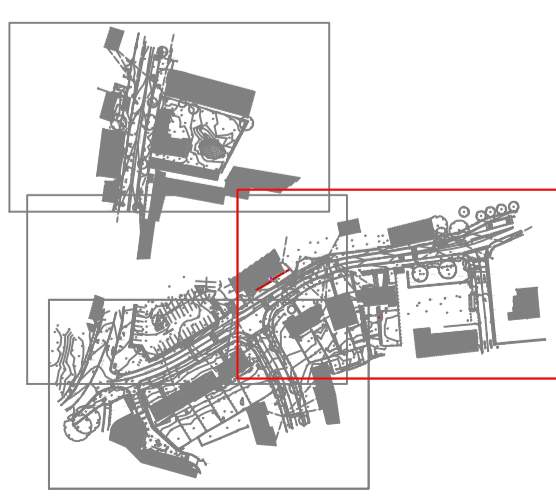

PLAN PRODUCED BY: APEX SURVEYS		CLIENT: Fingal County Council		PROJECT: Seatown Road and North Street, Swords																
CONTACT INFORMATION: Apex Surveys Unit 78 Dunboyne Business Park Dunboyne, Co. Meath, Ireland www.apexsurveys.ie info@apexsurveys.ie 00353 1 691 0156		GRID SYSTEM: Irish Transverse Mercator DATUM: Malin Head (OSGM15) NOTES: Drawing Contains Scale Factor		SCALE : 1/200 A1 DATE : 27/07/2022																
REVISIONS: <table border="1"> <thead> <tr> <th>No.</th> <th>Date</th> <th>Description</th> </tr> </thead> <tbody> <tr> <td>001</td> <td>N/A</td> <td>Original Drawing</td> </tr> <tr> <td>002</td> <td>27/06/22</td> <td>Adding Missing Ridge on the North</td> </tr> <tr> <td>003</td> <td>04/07/22</td> <td>Additional Information Added</td> </tr> <tr> <td>004</td> <td>27/07/22</td> <td>Additional Information Added</td> </tr> </tbody> </table>		No.	Date	Description	001	N/A	Original Drawing	002	27/06/22	Adding Missing Ridge on the North	003	04/07/22	Additional Information Added	004	27/07/22	Additional Information Added	DRG No: 5176 SHEET: 4 of 4		DESCRIPTION : 2D Topographical SURVEYED BY : Jason Phingale PROCESSED BY : G.M.&D.B. CHECKED BY : Alan Brady	
No.	Date	Description																		
001	N/A	Original Drawing																		
002	27/06/22	Adding Missing Ridge on the North																		
003	04/07/22	Additional Information Added																		
004	27/07/22	Additional Information Added																		