



Waste Water Discharge Authorisation

Application Form

EPA Ref. No.: (Office use only)	<input type="text"/>
---	----------------------

Consent of Copyright owner required for any other use.
For inspection purposes only.

Environmental Protection Agency

PO Box 3000, Johnstown Castle Estate, Co. Wexford

Lo Call: 1890 335599 Telephone: 053-9160600 Fax: 053-9160699

Web: www.epa.ie Email: info@epa.ie

ABOUT THIS APPLICATION FORM

This Application Form is for the purpose of making an application for a Waste Water Discharge Authorisation under the European Union (Waste Water Discharge) Regulations 2007 to 2020, or for the review of an existing Waste Water Discharge authorisation. It should be completed in accordance with the Guidance Document which is available on www.epa.ie.

A valid application for a Waste Water Discharge Authorisation must contain the information prescribed in the European Union (Waste Water Discharge) Regulations 2007 to 2020. Regulations 16 and 24 set out the statutory information requirements for a Waste Water Discharge licence (WWDL) and a Certificate of Authorisation (CoA) application respectively.

Neither this Application Form nor the guidance document purport to be and should not be considered a legal interpretation of the provisions and requirements of the European Union (Waste Water Discharge) Regulations 2007 to 2020.

While every effort has been made to ensure the accuracy of the material contained in this Application Form, the EPA assumes no responsibility and gives no guarantees, undertakings or warranties concerning the accuracy, completeness or up-to-date nature of the information provided herein and does not accept any liability whatsoever arising from any errors or omissions.

Should there be any contradiction between the information requirements set out in this Application Form and any clarifying explanation contained in the Guidance Note, then the requirements in this Application Form should take precedence. The requirements of the Regulations shall take precedence over any considerations mentioned in this Application Form, the guidance document or on the website.

The Application Form comprises sections A-E as follows:

Section A:	Non-Technical Summary
Section B:	General
Section C:	Discharges & Monitoring
Section D:	Impact Assessment
Section E:	Declaration

SECTION A: NON-TECHNICAL SUMMARY

Advice on completing this section is provided in the accompanying Guidance Document.

A.1 Non-Technical Summary

This part of the Application Form collects a Non-Technical Summary which identifies all environmental impacts of significance associated with the discharge of waste water from the waste water works.

A1.1 Supporting documents

Complete the following table and submit the relevant supporting document as Attachment A1 in accordance with the guidance.

Table 1 - Non-Technical Summary Document Name

Document type	Document name
Non-technical summary	Attachment A.1.1: Non-Technical Summary Attachment A.1.2: Map 1 - Area of Interest

For inspection purposes only.
Consent of copyright owner required for any other use.

SECTION B: GENERAL

Advice on completing this section is provided in the accompanying Guidance Document.

B.1 Application Details

This part of the form collects contact details, the type of application, and the location and size of the agglomeration.

B.1.1 Application Type

This part of the form collects details of the type of application being made.

Table 2 – Application Type

		Tick as appropriate (✓)
A	Application for the review of an existing authorisation	
B	New application for a licence in respect of which the Agency has previously granted a certificate	✓
C	New application for a licence for discharges (>500 P.E)	
D	New application for a certificate for discharges (< 500 P.E.)	

Following an upgrade in 2018, the current design p.e of the Naul WwTP is 650. An interim upgrade, consisting of mechanical and electrical works with small scale civil works, is now proposed to cater for new growth in the agglomeration. The upgrade will involve increasing the capacity of the plant to cater for 745 p.e. whilst also improving the treatment process (Nitrogen & Phosphorus removal) within the plant.

Discharges from the Naul agglomeration are currently authorised under Certificates of Authorisation (CoA) A0103-01. The WwTP is currently collecting loads in excess of 500 p.e. (ca. 674 p.e., 2020 peak week loading) and after the proposed interim upgrade has been completed, the organic design capacity of the plant will be 745 p.e. As there is an increase in the p.e. to which a certificate of authorisation relates, an application for a waste water discharge licence is now required.

If A or B are applicable, provide the following information:

Current EPA Authorisation Register Number(s)	A0103-01
--	----------

If A is applicable, provide the following information:

Grounds for review on which the application is being made:
Not applicable

If C or D are applicable, provide the following information:

Date on which the waste water works became / becomes operational:	It is currently programmed for the Naul WwTP interim upgrade works to commence in Q2/Q3 2022 and for the WwTP to be fully operational by Q4 2022 / Q1 2023.
---	---

In the case of an application for a licence (review), confirm the agglomeration population equivalent (p.e.):

Table 3 - Agglomeration p.e. thresholds

Discharges from agglomerations with a p.e. of	Tick as appropriate (✓)
more than 10,000	
2,001 to 10,000	
1,001 to 2,000	
500 to 1,000	✓

B.1.2 Applicant's Details

Provide the following information:

Table 4 - Name and Address of Applicant

Name*:	Irish Water
Address:	Colvill House 24-26 Talbot Street Dublin 1
CRO Number:	530363
Tel:	01 8925000

e-mail:	WastewaterLicensingEasternMidlands@water.ie
---------	---

**This should be the name of the water services authority in whose ownership or control the waste water works is vested.*

Note that only application documentation submitted by the applicant and by the nominated person will be deemed to have come from the applicant.

Table 5 – Name and Address for Correspondence

Name*:	Dara White (Regional Wastewater Treatment Specialist)
Address:	Colvill House 24-26 Talbot Street Dublin 1
Tel:	01 8925000
e-mail:	WastewaterLicensingEasternMidlands@water.ie

**This should be the name of person nominated by the water services authority for the purposes of the application.*

B.2. Agglomeration Details

This part of the form collects details of the agglomeration, the waste water works and any associated waste water treatment plant, capacity details and waste water inputs.

B.2.1 Agglomeration name and Geographical Location

Table 6 - Agglomeration Name and Location

Name of Agglomeration:	Naul
Name of townland or townlands of the agglomeration served by a waste water works to which the application relates:	Naul
Included on EPA Waste Water Priority List?	No
Included on European Commission infringement list?	No

B.2.2 Waste water works and associated Waste Water Treatment Plant(s)

Table 7 - Waste Water Works

<p>Description of the existing waste water works:</p>	<p>The Naul agglomeration is centred on the village of Naul. The current plant is designed for a population equivalent (p.e.) of 650. The WwTP is currently collecting loads of <i>ca.</i> 674 p.e.</p> <p>Wastewater flows by gravity to the WwTP. The plant provides secondary treatment <i>via</i> a conventional activated sludge plant (biological treatment process) designed to reduce the biological load to the standards required by the Urban Wastewater Treatment (UWWT) Regulation (S.I. No. 254 of 2001).</p> <p>The excess sludge produced in the plant is tankered to Oldtown WwTP where it is dewatered and used in land remediation.</p> <p>The current inefficiencies of the WwTP relate predominately to dilute influent and a deficient activated sludge system.</p> <p>There are two sources of emissions from the agglomeration. The primary discharge (SW001), which operates 24hrs a day and 365 days a year, discharges to the Delvin River (Delvin_020) <i>via</i> a flow measured primary discharge outfall pipe at NGR 313239E, 261155N. There is an ultrasonic flowmeter on this outfall.</p> <p>There is one Storm Water Overflow (SW002) located at the head of the plant. This overflow is activated during major rainfall events, when diluted influent overtops the weir and discharges to the Delvin River <i>via</i> the primary discharge outfall pipe.</p> <p>There are no emergency overflows within the agglomeration.</p> <p>There are no pumping stations within the agglomeration.</p>
<p>Description of proposed development, if any, to which the application relates:</p>	<p>The proposed interim upgrade works at the Naul WwTP will cater for new growth in the agglomeration by providing the following upgrades works:</p>

For inspection purposes only. Consent of copyright owner required for any other use.

	<ul style="list-style-type: none"> • Modifications to overflow weir in the inlet works and provision of a new inlet chamber. • Installation of fine bubble diffuser aeration system into the existing aeration tank. • 2 no. new air blowers and associated pipework. • Installation of a ferric dosing system including pumps, storage tanks dosing pipework and emergency shower. • New return activated sludge and waste activated sludge pumps in existing Return Activated Sludge (RAS) / Waste Activated Sludge (WAS) concrete chamber. • SCADA and electrical works associated with the above. <p>The interim upgrade to the WwTP will optimise the existing treatment process and also cater for additional capacity up to 745 p.e.</p> <p>The proposed ELVs for final effluent quality from the upgraded plant are as follows:</p> <ul style="list-style-type: none"> • Biological Oxygen Demand (BOD) – 25mg/l • Chemical Oxygen Demand (COD) – 125 mg/l • Suspended Solids (SS) – 35mg/l • Ammonia (as N) (mg/l) – 1.6mg/l • Ortho-phosphate (as P) – 1 mg/l <p>The proposed ELVs have been set by IW to ensure that the operational discharges from the Naul agglomeration contribute towards achieving at least Good status in accordance with the European Union Environmental Objectives (Surface Waters) (Amendment). Regulations 2019 (S.I. No. 77 of 2019) and in maintaining the current High status of Ammonium in the Delvin_020.</p> <p>The improvements to the WwTP will ensure a higher standard of treatment, with N and P removal, thereby reducing the concentration and frequency of the sludge washout effluent.</p> <p>SW002 at the upgraded WwTP will not meet the criteria as set out in the DoEHLG 'Procedures</p>
--	--

For inspection purposes only. Consent of copyright owner required for any other use.

	<p>and Criteria in Relation to Storm Water Overflows’, 1995. However, Irish Water are proposing a further upgrade to the works to increase capacity of the plant to 900 p.e. under the Small Towns & Villages Growth Programme (STVP) and the provision of a storm tank is likely to be progressed under the IWSS or the STVP programme subject to statutory and budgetary approvals.</p> <p>Overflows from SW002 will be screened prior to discharging to the Delvin River.</p> <p>There is no emergency overflow at the WwTP.</p> <p>The primary treated effluent and SWO will continue to discharge <i>via</i> the existing outfall at NGR 313239E, 261155N.</p>
<p>Number and type of waste water discharges from the waste water works including proposed waste water discharges:</p>	<p>Primary Discharge (now SW001): The primary discharge at 313239E, 261155N discharges treated effluent to the Delvin River <i>via</i> a flow measurement flume.</p> <p>Secondary Discharges: There are no secondary discharge points associated with the current waste water works.</p> <p>Storm Water Overflow (now SW002) SW002 at the head of the WwTP and downstream of the screen, when activated will discharge <i>via</i> the primary discharge outfall at NGR 313239E, 261155N.</p>
<p>Is the network assessment complete?</p>	<p>Not applicable as no overflows on network.</p>
<p>If the answer above is no, in what year is the assessment expected to be complete?</p>	<p>Not applicable</p>

Table 8 - Waste water treatment plant associated with the waste water works

Site contact Name*:	Joanne McGuinness (Regional Compliance Specialist)
Address of waste water treatment plant (including Eircode):	Naul WWTP Naul, Co Dublin (No Eircode)
Telephone Number:	01 8925000
e-mail:	WastewaterLicensingEasternMidlands@water.ie
Grid ref (6E, 6N)	313239E, 261134N
Description of the treatment process	Secondary Treatment (with N and P removal)
Primary discharge point reference ID:	SW001

*This should be the name of the person responsible for the supervision of the waste water treatment plant.

B.2.3 Supporting documents

Complete the following table and submit the relevant supporting documents in accordance with the Guidance Document:

Table 9 - Supporting Document Names

Document type	Document name
B.2 .1 Agglomeration map	Attachment B.2.1: Map 2 - Agglomeration Plan
B.2-2 Site map including discharge and monitoring points.	Attachment B.2.2: Map 3 - WwTP Site Location Plan Attachment B.2.2: Map 4 – Location Primary Discharge Point Attachment B.2.2: Map 5 – Location Storm Water Overflow Attachment B.2.2: Map 6 – Location of Ambient Monitoring Points
B.2.3 Waste water process flow	Attachment B.2.3: Waste Water Process Flow Diagram

B.2.4 Capacity of the waste water works

Table 10 - Capacity of the Waste water Works

Population Equivalent of the agglomeration to which the application relates:	745 p.e. (Proposed Design)
Maximum average weekly population equivalent of the agglomeration:	Current - 506 (calculated based on 75% of 2020 peak weekly loading)
Existing Organic Capacity of the waste water treatment plant - As Constructed or nominal design (p.e.)	650 p.e. (Design since 2018)
Proposed Organic Capacity of the waste water treatment plant - As per planning permission or design (p.e.)	745 p.e.
Current Collected Load (p.e.):	674 p.e (2020 peak weekly loading)
Remaining Organic Capacity (p.e.):	0 p.e. (based on current collected load)
Is the plant overloaded – organic loading?	Yes
Current Peak Hydraulic Capacity of the waste water works–As Constructed or nominal design (m ³ /day):	438.75 m ³ /day (Current Design)
Proposed Peak Hydraulic Capacity of the waste water works–As per planning permission or nominal design (m ³ /day):	502.88 m ³ /day (Proposed Design)
Current and proposed dry weather flow (DWF) to the treatment plant (m ³ /day):	146.25 m ³ /day (Current Design DWF) 167.6 m ³ /day (Proposed Design DWF)
Current average hydraulic loading to the treatment plant (m ³ /day):	377m ³ /d (based on influent flows from 27 th Nov 2020 to 26 th Nov 2021)
Remaining Hydraulic Capacity (m ³ /day):	61.75 m ³ /day (based on Current Design) 125.88 m ³ /day (based on Proposed Design)
Is the plant hydraulically overloaded?	No

B.2.5 Waste Water Inputs

Table 11 - Waste Water Inputs to Waste Water Works

Inputs	P.E.	% of total PE
Domestic waste water load (includes small commercial load)	745	100 %
Industrial waste water load	0	0
Leachate	0	0
Waste water to be conveyed and discharged only (i.e. by pass the WWTP)	0	0
Total	745	100 %

Where industrial waste water is relevant to this application, provide the following information:

Table 12 - Industrial waste water pre-treatment

A	Is the requirement for pre-treatment (Article 9 of the urban waste water treatment regulations 2001 as amended) met?	No
---	--	----

If 'No' was answered to A, provide details of the measures to be taken to comply:

Not applicable

For inspection purposes only. Consent of copyright owner required for any other use.

B.3 Planning documentation

B.3.1 Planning information

This part of the application form collects planning information relating to development or proposed development relevant to which the application relates.

Table 13 - Planning Status

	Planning Authority name:	Not applicable
A	Is planning permission required for development or proposed development to which the application relates?	No
B	If 'Yes', has planning permission been granted?	Not applicable
C	If planning permission is not required at A above, is the proposed development, if any, to which the application relates exempted development?	Yes

If 'Yes' was answered to A and B, above, the following 'Planning Granted' table should be completed.

Table 14 - Planning granted

Planning File Reference Number:	Not applicable
Planning Appeal Reference Number (if relevant):	
Planning Authority Name / An Bord Pleanála:	
Date of Planning Decision (Final Grant):	
Brief description:	
EIAR required with Planning Application?	
Confirm that the supporting documentation is provided:	

If 'Yes' was answered to A and 'No' was answered to B, above, the following Planning under Consideration table should be completed.

Table 15 - Planning under Consideration

Planning File Reference Number:	Not applicable
Planning Appeal Reference Number (if relevant):	
Planning Authority Name / An Bord Pleanála:	
Date of application:	
Brief description:	
EIAR required with Planning Application?	
Confirm that the supporting documentation is provided:	

If 'No' was answered to A and 'Yes' was answered to C, the following Exempted Development table should be completed.

Table 16 - Exempted Development

Reason for exemption:	<p>The proposed WwTP interim upgrade works is exempted development under Class 58 of Schedule 2 of the Planning and Development Regulations, as amended; <i>The construction or erection of either or both— (i) below ground pumping or booster stations and, where appropriate, above ground kiosks, and (ii) below ground holding tanks or reservoirs.</i></p> <p>None of the restrictions as per Article 9 of the Planning and Development Regulations 2001, as amended, apply to the Naul WwTP interim upgrade project.</p>
-----------------------	---

B.3.2 Supporting documents

The document names for all supporting documentation should be provided in the following table.

Table 17 - Supporting Documents

	Document type	Document name
Planning granted	- planners letter confirming EIA is not required (if relevant)	Not applicable
	- a copy of relevant grant of planning permission AND planners report	Not applicable
Planning under consideration	- confirmation from a planning authority or An Bord Pleanála (as applicable) that an application for permission comprising or for the purposes of the waste water discharge to which the application relates, is currently under consideration by the planning authority concerned or An Bord Pleanála	Not applicable
	- Planners letter confirming EIA not required (if relevant)	Not applicable
Exempted development	- Planners letter confirming development is exempted or reference to the specific legislation for exemption.	Not applicable, see Table 16 above for exemption details.

B.4 Notices and Advertisements

This part of the form collects evidence of stakeholder engagement prior to making this application. The location of the site notice should be provided in the following table.

Table 18 - Site notice location

Grid co-ordinates (6E, 6N)	313162E	261128N
----------------------------	---------	---------

B.4.1 Supporting documents

The document names for all supporting documentation should be provided in the following table:

Table 19 - Names of Supporting Document(s) on Notices and Advertisements

Document type	Document name
Newspaper notice:	Attachment B.4.1: Newspaper Notice
Site notice:	Attachment B.4.2: Site Notice
Map of site notice location:	Attachment B.4.3: Map 7 - Site Notice Location
Water Services Authority notice:	Not applicable
EIA Portal Confirmation notice:	Not applicable

For inspection purposes only.
 Consent of copyright owner required for any other use.

B.5 Preliminary examination/EIA Screening/EIAR

This part of the application form collects information in relation to EIA and the development /proposed development comprising or for the purposes of the waste water discharge.

Table 20 - EIA related information.

A	Having regard to B.3, is this application accompanied by an EIAR?	No
B	Is the application in respect of the waste water discharge from a waste water treatment plant with a capacity of greater than 10,000 population equivalents as defined in Article 2, point (6), of the Urban Water Water Treatment Directive	No
C	Are there other competent authorities conducting EIA for the development or proposed development to which this application relates?	No
D	If 'Yes' to C, provide the name of the competent authority and consent reference	Not applicable

If the answer to either A or B is 'Yes', the EIAR must accompany the application.

Preliminary Environmental Impact Assessment (EIA) Screening:

The subject matter of this application (i.e., operational discharges from the Naul agglomeration) falls well below the threshold of Regulation 17 (i) of S.I No. 214 of 2020 and is not a WwTP specified in accordance with paragraph (6)(c) or (8)(b)(ii) of Regulation 18 or paragraph (3)(c) or (5)(b)(ii) of Regulation 25.

Based on the above, it can be confidently concluded that the subject matter of this application, due to its size, scale, location, and nature, would have no real likelihood of significant effects on the environment, and therefore an Environmental Impact Assessment (EIA) and the production of an Environmental Impact Assessment Report (EIAR) is not required to support this application.

B.5.1 Supporting documents

The names assigned to the documents should be provided in the following table:

Table 21 - Names of Supporting Document(s) on EIA

Document type	Document name
EIAR	Not applicable
Preliminary examination / EIA screening report	Attachment B.5: Preliminary EIA Screening Report

B.6. Compliance with EU Directives & National Regulations

This part of the application form collects details on compliance with relevant EU Directives and national Regulations.

B.6.1 Supporting document

The EPA template provided should be completed. The name assigned to the document should be provided in the following table:

Table 22 - Names of Supporting Document on Compliance with EU Directives and National Regulations

Document type	Document name
Compliance with EU Directives & National Regulations	Attachment B.6: Compliance with EU Directives & National Regulations

*For inspection purposes only.
Consent of copyright owner required for any other use.*

B.7 Foreshore Act Licences.

This part of the application form collects information relating to Foreshore Act Licences where relevant.

Is Foreshore Act Licence required for development or proposed development the subject of this application?	Not applicable
--	----------------

If yes, and the Foreshore Act Licence is relevant to this application, provide the following information:

Table 23 -Foreshore Act Licence

	Foreshore Act Licence Competent Authority name:	Not applicable
A	Has a Foreshore Act Licence being granted?	
B	If no to A, is a Foreshore Act Licence application under consideration by the relevant competent authority?	
C	Was EIA carried out or will be carried out by the Foreshore Act Licence competent authority?	
D	If 'Yes' to C, confirm that the same EIAR was submitted to Foreshore competent authority as accompanied this WWDA application:	
E	If 'Yes' to A, provide: <ul style="list-style-type: none"> - Licence Reference Number, and - date of grant of consent: 	
G	If 'Yes' to B, provide application reference number	

B.7.1 Supporting documents

The name(s) assigned to all supporting documentation should be provided in the following table:

Table B22 - Supporting documents

	Document type	Document name
If 'Yes' to A	Foreshore Act Licence:	Not applicable
If 'Yes' to C	Foreshore Act Licence report:	Not applicable

B.8 Programme of Improvements

For licence review applications, provide information on current licence requirements with respect to specified improvement works (B.8.1) and Condition 5 improvement programme (B.8.2).

For all applications, provide information on planned improvements (B.8.3). Supporting information can be uploaded / attached to this part of the application form.

B.8.1 Specified Improvement Programme

In the case of a licence review are there specified improvement works in Schedule A and C of current licence?	Not applicable
---	----------------

If 'Yes', the following table should be completed for each specified improvement works.

Table 23 - Schedule A & C Improvement Programme

Specified Improvement Programmes: (under Schedule A and C of WWDL)	Not applicable
Date for completion of Improvement Programme in the licence:	
Has the date for completion expired? (Enter N, N/A or Y)	
Status of works: <i>e.g. (i) Not Started; (ii) At planning stage; (iii) Work ongoing on-site; (iv) Commissioning phase; (v) Completed; (vi) Delayed</i>	
Irish Water's expected timeframe for completing the work	
Comments: Not applicable	

B.8.2 Condition 5 Improvement programme

Provide details of the Condition 5 improvement programme by completing the following table:

Table 24 - Condition 5 Improvement Programme

Improvement identifier:	Not applicable
Improvement description:	
Improvement source: <i>(e.g. WWTP assessment, Sewer assessments, Secondary discharges assessment SWO assessment, Drinking Water Abstraction Risk Assessment, Shellfish Impact Risk Assessment, Pearl Mussel Impact Assessment, Improved Operational Control, Incident Reduction, Elimination/Reduction of Priority Substances, Process Optimisation)</i>	
Status of works:	
Expected Completion date:	
Comments:	

B.8.3 Planned programme of improvements

Provide information on planned programme of improvements by completing the following table:

Table 25 -Planned Programme of Improvements

Waste water discharge reference code:	SW001
Type: (primary discharge / secondary discharge/ storm water overflow)	Primary Discharge
Improvement works description:	<p>The proposed interim upgrade works at Naul WwTP will cater for new growth in the agglomeration whilst also improving the treatment process within the plant by providing the following upgrades primarily consisting of mechanical and electrical works with small scale civil works also required: -</p> <ul style="list-style-type: none"> • Modifications to overflow weir in the inlet works and provision of a new inlet chamber. • Installation of fine bubble diffuser aeration system into the existing aeration tank.

	<ul style="list-style-type: none"> • 2 no. new air blowers and associated pipework. • Installation of a ferric dosing system including pumps, storage tanks dosing pipework and emergency shower. • New return activated sludge and waste activated sludge pumps in existing Return Activated Sludge (RAS) / Waste Activated Sludge (WAS) concrete chamber. • SCADA and electrical works associated with the above.
Expected completion date:	It is currently programmed for the Naul WwTP interim upgrade works to commence in Q2 / Q3 2022 and for the WwTP to be fully operational by Q4 2022 / Q1 2023.
Planning status: (grant of permission / exempted development)	Exempted Development
Prioritised for funding:	N/A

Note: SW002 at the upgraded WwTP will not meet the criteria as set out in the DoEHLG 'Procedures and Criteria in Relation to Storm Water Overflows', 1995. However, Irish Water are proposing a further upgrade to the works to increase capacity of the plant to 900 p.e. under the small Towns & Villages Growth Programme (STVP) and the provision of a storm tank is likely to be progressed under the IWSS or the STVP programme subject to statutory and budgetary approvals.

B.8.4 Supporting documents

Attachment B8 should be submitted in accordance with the Guidance Document as supporting information and the name assigned to it provided in the following table:

Table 26 - Supporting documents

Document type	Document name
Improvement programme	Not applicable, refer to Table 25 above for details on proposed improvements and anticipated programme for same.

B.9 Fees

State the appropriate fee as per Columns 2 or 3 of the Third Schedule of the European Union (Waste Water Discharge) Regulations 2007 to 2020.

Table 27 - Fee

Class of Waste Water Discharge		Fee accompanying application / review application (in €)
Discharges from agglomerations with a population equivalent of:	(tick [✓] one as appropriate)	
- more than 10,000		€10,000
- 2,001 to 10,000		
- 1,001 to 2,000		
- 500 to 1,000	✓	
- less than 500		

For inspection purposes only.
Consent of copyright owner required for any other use.

SECTION C: DISCHARGES & MONITORING

C.1. Discharges & Monitoring

The Discharges & Monitoring template should be downloaded from the EPA website (www.epa.ie), completed and submitted in accordance with the Guidance Document.

C.1.1 Supporting document

Attachment C.1 should be submitted in accordance with the Guidance Document as supporting information and the name assigned to it provided in the following table:

Table 28 - Discharges & Monitoring

Document type	Document name
Discharges & Monitoring	Attachment C.1: Discharges and Monitoring

C.2. Measures to Prevent Unintended Discharges

Existing and proposed measures should be identified in the table below. Additional measures may be added to this table as required.

Table 29 -Prevention Measures & Monitoring

Measures to prevent unintended discharges	Existing (Y/N)	Proposed (Y/N)	Applicability	Surveillance measure
Accident prevention procedure:	N	Y	-	Flow distribution chamber valves to be provided with lock system to prevent unintended discharges. Adjustments to be made by operator or trained personnel only.
Emergency Response Plan and Procedures:	N	Y	-	Alarms for WwTP to be fed to SCADA with alarms sent to operators.
Waste water treatment plant				
Measures to prevent unintended discharges	Existing (Y/N)	Proposed (Y/N)	Applicability	Surveillance measure
Alarms / telemetry on waste water treatment plant:	N	Y	-	Alarms for WwTP fed to SCADA with alarms sent to operators.
Standby pumps at waste water treatment plant:	N	N	N/A	WwTP hydraulically fed by gravity.

Standby equipment or provisions in the event of interruption of the power supply such as a portable generator or equipment with automatic switchover:	N	Y	-	Connection provided for connecting mobile generator. Uninterruptible Power Supply (UPS) backup for telemetry/plant controllers.
Storage capacity at intake to the waste water treatment plant (SWO tank):	N	N	N/A	Storm storage not provided as part of interim upgrade.
Groundwater monitoring:	N/A	N/A	N/A	N/A

Network				
Measures to prevent unintended discharges	Existing (Y/N)	Proposed (Y/N)	Applicability	Surveillance measure
Alarms / telemetry on pumping stations:	N/A	N/A	N/A	N/A
Alarms / telemetry on emergency overflows:	N/A	N/A	N/A	N/A
Standby pumps at pumping stations:	N/A	N/A	N/A	N/A
Standby equipment or provisions in the event of interruption of the power supply:	N/A	N/A	N/A	N/A
Storage capacity at pump stations:	N/A	N/A	N/A	N/A
Monitoring telemetry on SWOs:	N/A	N/A	N/A	N/A
Additional measures:	N/A	N/A	N/A	N/A

C.2.1 Supporting documents

Attachment C2 should be submitted (in accordance with the Guidance Document) as supporting information and the name assigned to it provided in the following table:

Table 30 - Supporting documents

Document type	Document name
Measures to prevent unintended discharges	Not applicable , refer to Table 29 above

SECTION D: IMPACT ASSESSMENT

D.1. Receiving Waters

Complete the tables, below, as appropriate, for primary discharge, secondary discharge and storm water overflow(s) (SWO).

Table 31 - Receiving waters of Primary Discharge

Type (river, lake, groundwater, coastal, transitional):	River
Name and WFD reference:	DELVIN_020, IE_EA_08D010250
WFD Risk:	At Risk
WFD Status & year:	Moderate (2013-2018)
WFD Objective & timeframe for achievement:	Good (2027)
Is the agglomeration identified as a significant pressure?	No
Has the discharges contributed to a deterioration in the quality of the water body?	No significant impact.
Protected areas in the vicinity of the discharges:	There are no designated or protected areas downstream (i.e., drinking water abstractions, bathing waters, shellfish waters, salmonid waters or <i>Margaritifera margaritifera</i>) of the discharges from the agglomeration.
Are there drinking water abstraction points downstream of waste water discharge points?	No
European sites hydrologically connected:	There is a tenuous indirect connectivity through surface water features to the River Nanny Estuary and Shore SPA <i>via ca.</i> >10 km of the Delvin River and on through <i>ca.</i> 2 km of the Irish Sea.
Trophic status of transitional / coastal waters:	Not applicable
Is there a groundwater protection scheme in place or to be provided in the vicinity of such discharge?	Not applicable
Status of adjacent waterbodies: (e.g. upstream and downstream of the receiving waterbody)	DELVIN_010 – Poor status (<i>ca.</i> 1.5 km) DELVIN_030 – Unassigned (<i>ca.</i> 4 km)

95%ile River Flow upstream of primary discharge point: (if applicable)	0.06 m ³ /s (Hydrometric Gauge Station 8002, Br NW of Forty Acres & confirmed with the EPA on the 8 th December 2021).
Receiving water monitoring stations: (code and distance from primary discharge point)	<p><u>U/S</u> RS08D010080 – ca. 1.5 km</p> <p><u>D/S</u> RS08D010250 – ca. 4 km</p> <p><i>Note: The monitoring locations above have been selected by IW based on Health and Safety grounds to ensure safe access during the collection of samples when implementing the monitoring regime.</i></p>

Refer to **Attachment D.1: Map 8** which displays the receiving water designations in the wider environs of the Naul WwTP.

Table 32 - Receiving waters of secondary discharges

Type (freshwater, lake etc.)	Not applicable
Name and WFD Ref.	Not applicable
WFD Risk	Not applicable
WFD Status (year)	Not applicable
WFD Objective (year)	Not applicable
Is the agglomeration identified as a significant pressure?	Not applicable
Have the discharges contributed to a deterioration in the quality of the water body?	Not applicable
Protected areas downstream	Not applicable
Are there drinking water abstraction points downstream of waste water discharge points?	Not applicable
European sites hydrologically connected	Not applicable
Trophic status of transitional / coastal waters	Not applicable
Is there a groundwater protection scheme in place or to be provided in the vicinity of such discharge?	Not applicable

Status of adjacent waterbodies (e.g. upstream and downstream of the receiving waterbody)	Not applicable
95%ile River Flow upstream of secondary discharge point (if applicable)	Not applicable
Receiving water monitoring stations upstream and downstream (code and distance from secondary discharge point)	Not applicable

Table 33- Receiving waters of discharges from SWOs (at WwTP)

Receiving Waters name and code	WFD status	No. of compliant SWOs ¹	No. of SWOs under assessment or remediation	Is the SWOs identified as a significant pressure?	WFD objective and date
DELVIN_020, IE_EA_08D010250	Moderate	0 ²	0	No	Good (2017)

¹ Compliant with DoECLG criteria set out in 'Procedures and Criteria in Relation to Storm Water Overflows'.

² SW002 at the upgraded WwTP will not meet the criteria as set out in the DoEHLG 'Procedures and Criteria in Relation to Storm Water Overflows', 1999. However, Irish Water are proposing a further upgrade to the works to increase capacity of the plant to 900 p.e. under the Small Towns & Villages Growth Programme (STVP) and the provision of a storm tank is likely to be progressed under the IWSS or the STVP programme subject to statutory and budgetary approvals.

Overflows from SW002 will be screened prior to discharging to the Delvin River.

Table 34 - Ambient monitoring – upstream monitoring point

EDEN Code (where applicable):	Not applicable as new application	
Licence Code:	Not applicable as new application	
Monitoring Location:	311989E	260676N
Point Type:	Upstream - aSW1u (RS08D010080 (Br W of Naul))	
Name of Receiving Water	Delvin River - DELVIN_010	

Table 35 - Ambient Monitoring – upstream monitoring results (Data 2019-Sept 2021: Source: catchments.ie)

Parameter	pH (pH Unit)	BOD (mg/l)	Ortho- phosphate (mg/l)	Total Ammonia (mg/l)	DO (mg/l)	DO (%sat)	Temp (°C)
Number of Samples	13	13	13	13	13	13	13
Max result	8.3	4.3	0.17	0.094	8.3	105	16.7
Min result	7.6	0.5	0.019	0.01	7.6	71	2.9
Average result	7.96	0.99	0.0715	0.0391	7.96	93.5	9.9
Mean EQS as per S.I. No. 77/2019		≤1.5**	≤0.035**	≤0.04*			
Overall compliance with relevant EQS (Mean)		Yes	No	Yes			

*Mean High status under S.I. No. 77/2019 – Ammonium is noted as High under 2013-2018 WFD status.

** Mean Good status under S.I. No. 77/2019

Table 36 - Ambient monitoring results – downstream

EDEN Code (where applicable):	Not applicable	
Licence Code:	Not applicable	
Monitoring Location:	14364E	263783N
Point Type:	Downstream - aSW1d (RS08D010250 (Br NW of Forty Acres))	
Name of Receiving Water	DELVIN_020	

Table 37 - Ambient Monitoring – downstream monitoring results (Data 2019-Sept 2021: Source: catchments.ie)

Parameter	pH (pH Unit)	BOD (mg/l)	Ortho- phosphate (mg/l)	Total Ammonia (mg/l)	DO (mg/l)	DO (%sat)	Temp (°C)
Number of Samples	13	13	13	13	13	13	13
Max result	8.4	2	0.17	0.11	13.5	118	17
Min result	8	0.5	0.021	0.01	8.8	89	3.2
Average result	8.2	0.785	0.078	0.033	11.3	101	10.12

Parameter	pH (pH Unit)	BOD (mg/l)	Ortho-phosphate (mg/l)	Total Ammonia (mg/l)	DO (mg/l)	DO (%sat)	Temp (°C)
Mean EQS as per S.I. No. 77/2019		≤1.5**	≤0.035**	≤0.04*			
Overall compliance with relevant EQS (Mean)		Yes	No	Yes			

*Mean High status under S.I. No. 77/2019 – Ammonium is noted as High under 2013-2018 WFD status.

** Mean Good status under S.I. No. 77/2019

Table 38 - Proposed Receiving Water Monitoring

EDEN Code (where applicable)	Licence Code	Monitoring Location				Point Type	Name of Receiving Water
Not applicable as new Application		311989	E	260676	N	Upstream aSWu	DELVIN_010
		314364	E	263783	N	Downstream aSWd	DELVIN_020

Table 39 - Proposed Monitoring Regime

Parameter	Units	Monitoring Frequency	Analysis method/Technique
pH	pH Unit	Quarterly	pH meter and recorder
BOD	mg/l	Quarterly	Standard Method
Suspended Solids	mg/l	Quarterly	Standard Method
DO	% O ₂	Quarterly	Electrode
DO	mg/l	Quarterly	Standard Method
Ortho-phosphate (as P)	mg/l	Quarterly	Standard Method
Ammonia (as N)	mg/l	Quarterly	Standard Method
Temperature	°C	Quarterly	Standard Method
Visual inspections	N/A	Weekly	Standard Method

D.2 Assessment of impact on receiving waters

This part of the application form collects reports on the assessment of the impact of existing and proposed waste water discharges on the environment including any environmental medium other than that into which the discharges take place or are to take place. The impact assessment reports address at least the impact on the quality of receiving waters (surface water or groundwater) and may, as appropriate, address European sites.

Where a Natura Impact Statement (NIS) does not accompany the application, you are required to provide an Appropriate Assessment (AA) screening report.

Is this application accompanied by an NIS?	No
--	----

D.2.1 Supporting document

The impact Assessment Report should be submitted (as Attachment D2) in accordance with the guidance and the name assigned to the attachment(s) provided in the table below.

Table 40 - Assessment Reports.

Document type	Document name
Impact assessment report	Attachment D.2.1: Impact Assessment Report
Natura Impact Statement	Not applicable
AA Screening Report	Attachment D.2.2: AA Screening Report
Waste Assimilative Capacity Calculations	Attachment D.2.3: Waste Assimilative Capacity (WAC)
Priority Substance Report	Attachment D.2.4: Priority Substance Assessment Report

D.3 Closing Remarks

This part of the application form is a short statement summarising the environmental outcome of your application and assessment.

State the environmental outcome of your application and assessment and reasons for same:

Answer here:

The proposed interim upgrade of the Naul WwTP has been designed to ensure that emissions from the plant will not result in the contravention of EU Directives and National Regulations.

Based on the proposed effluent discharge standards/ELVs, and the WAC calculations carried out for same using the EPA's notional clean river approach and the actual background river concentrations, along with the conclusions of the AA Screening Report, Priority Substances Assessment Report and Impact Assessment Report which support this application, it is considered that the operational discharges from the Naul agglomeration will have no real likelihood of significant effects on the receiving aquatic environment.

The proposed ELVs (BOD 25mg/l, Total-Ammonia (as N) 1.6mg/l, and Ortho-P (as P) 1 mg/l) have been set by IW to ensure that the operational discharges from the Naul agglomeration contribute towards the WFD objective of the Delvin River of achieving at least Good status in accordance with the European Union Environmental Objectives (Surface Waters) (Amendment) Regulations 2019 (S.I. No. 77 of 2019) by 2027, and to ensure that the High WFD status of Ammonium is maintained.

In summary, Irish Water is committed to ensuring that the Naul WwTP operates in a manner that supports the achievement of the water body objectives under the Water Framework Directive, and their obligations under the Birds and Habitats Directives and all applicable Directives and National Regulations and in ensuring that there is no environmental risk posed to the receiving water environment as a result of the discharges from the Naul agglomeration.

For inspection purposes only
Consent of copyright owner required for any other use

SECTION E: DECLARATION

E.1. Declaration

The Signed Declaration template should be downloaded from the EPA website (www.epa.ie), completed and submitted in accordance with the Guidance Document.

E.1.1 Supporting documentation

The name assigned to the Signed Declaration document should be provided in the following table:

Table 41 - Signed Declaration document name

Document type	Document name
Declaration	Attachment E.1: Signed Declaration

END

For inspection purposes only.
Consent of copyright owner required for any other use.

ATTACHMENTS

SECTION A: NON-TECHNICAL SUMMARY

Attachment A.1: Non-Technical Summary

A.1.1: Non-Technical Summary

A.1.2: Map 1 - Area of Interest

SECTION B: GENERAL

Attachment B.2: Agglomeration Details

Attachment B.2.1: Map 2 - Agglomeration Plan

Attachment B.2.2: Map 3 - WwTP Site Location Plan

Attachment B.2.2: Map 4 - Location of Primary Discharge Point

Attachment B.2.2: Map 5 - Location of Storm Water Overflow

Attachment B.2.2: Map 6 - Location of Ambient Monitoring Point

Attachment B.2.3: Waste Water Process Flow Diagram

Attachment B.4: Notices and Advertisements

B.4.1: Newspaper Notice

B.4.2: Site Notice

B.4.3: Map 7 - Site Notice Location

Attachment B.5: Preliminary Examination/EIA Screening

B.5: Preliminary EIA Screening Report

Attachment B6: Compliance with EU Directives & National Regulations

B.6: Compliance with EU Directives & National Regulations

SECTION C: DISCHARGES & MONITORING

Attachment C.1 Discharges and Monitoring

C.1: Discharges and Monitoring

SECTION D: IMPACT ASSESSMENT

Attachment D.1: Receiving Waters

D.1: Map 8 - Receiving Water Designations

Attachment D.2: Assessment of Impact on Receiving Waters

D.2.1: Impact Assessment Report

D.2.2: AA Screening Report

D.2.3: Waste Assimilative Capacity (WAC)

D.2.4: Priority Substance Assessment Report

SECTION E: DECLARATION

Attachment E.1 Declaration

E.1: Signed Declaration

*For inspection purposes only.
Consent of copyright owner required for any other use.*



SECTION A: NON-TECHNICAL SUMMARY

*For inspection purposes only.
Consent of copyright owner required for any other use.*

ATTACHMENT A.1.1 NON-TECHNICAL SUMMARY

1. Introduction

Following an upgrade in 2018, the current design p.e of the Naul WwTP is 650. An interim upgrade, consisting of mechanical and electrical works with small scale civil works, is now proposed to cater for new growth in the agglomeration. The upgrade will involve increasing the capacity of the plant to cater for 745 p.e. whilst also improving the treatment process (Nitrogen & Phosphorus removal).

It is currently programmed for the Naul WwTP interim upgrade works (planning exempted development) to commence in Q2 / Q3 2022 and for the WwTP to be fully operational by Q4 2022 / Q1 2023.

Discharges from the Naul agglomeration are currently authorised under Certificate of Authorisation (CoA) A0103-01. The WwTP is currently collecting loads in excess of 500 p.e. (ca. 674 p.e., 2020 peak week loading) and after the proposed interim upgrade has been completed, the organic design capacity of the plant will be 745 p.e.

As there is an increase in the p.e. to which a CoA relates, an application for a waste water discharge licence is now required.

Refer to **Attachment A.1.2** for the area of interest and **Attachment B.2.1** for a map of the Naul agglomeration.

2. Description of the waste water discharges from the waste water works serving the agglomeration

Existing Discharges:

Primary Discharge (SW001):

The primary discharge (SW001), which operates 24hrs a day and 365 days a year, discharges to the Delvin River at NGR 313239E, 261155N (erroneously cited as NGR 313231E, 261172N in previous CoA). There is an ultrasonic flowmeter on this outfall.

Secondary Discharges:

There are no secondary discharge points associated with the current waste water works.

Storm Water Overflow (SW002):

There is one Storm Water Overflow (SW002) located at the head of the plant. This overflow is activated during major rainfall events, when diluted influent overtops the weir and discharges to the Delvin River *via* the primary discharge outfall pipe.

Proposed Discharges:

Primary Discharge (now SW001):

The primary discharge (SW001) from the upgraded WwTP will operate 24hrs a day and 365 days a year and will continue to discharge to the Delvin River *via* the existing primary outfall at NGR 313239E, 261155N.

Secondary Discharges:

There are no secondary discharge points associated with the proposed waste water works.

Storm Water Overflow (now SW002)

SW002 at the head of the WwTP will be activated during major rainfall events, leading to diluted influent overtopping the weir and flowing through a screen and then overflowing to the Delvin River *via* the primary discharge outfall pipe.

SW002 at the upgraded WwTP will not meet the criteria as set out in the DoEHLG 'Procedures and Criteria in Relation to Storm Water Overflows', 1995. However, Irish Water are proposing a further upgrade to the works to increase capacity of the plant to 900 p.e. under the Small Towns & Villages Growth Programme (STVP) and the provision of a storm tank is likely to be progressed under the IWSS or the STVP programme subject to statutory and budgetary approvals.

Refer to **Attachment B.2.2: Map 4, Map 5, and Map 6** for the location of the proposed discharges.

3. Description of the wastewater works and associated waste water treatment plant

Existing Situation:

The Naul agglomeration is centred on the village of Naul. The current plant is designed for a population equivalent (p.e.) of 650 and is currently collecting loads of *ca.* 674 p.e.

Wastewater flows by gravity to the WwTP. The plant provides secondary treatment *via* a conventional activated sludge plant (biological treatment process) designed to reduce the biological load to the standards required by the Urban Wastewater Treatment (UWWT) Regulation (S.I. No. 254 of 2001).

The excess sludge produced in the plant is tankered to Oldtown WwTP where it is dewatered and used in land remediation.

The current inefficiencies of the WwTP relate predominately to dilute influent and a deficient activated sludge system.

Refer **Section 2** above for details on existing discharges from the WwTP.

There are no pumping stations within the agglomeration.

Proposed Works:

The upgraded WwTP with a design capacity of 745 p.e, will provide secondary treatment with N and P removal to the waste water generated within the Naul Agglomeration (refer to **Attachment B.2.1 Map 2** for the WwTP site location plan).

The proposed upgrade will entail the following works:

- Modifications to overflow weir in the inlet works and provision of a new inlet chamber
- Installation of fine bubble diffuser aeration system into the existing aeration tank
- 2 no. new air blowers and associated pipework
- Installation of a ferric dosing system including pumps, storage tanks dosing pipework and emergency shower
- New return activated sludge and waste activated sludge pumps in existing Return Activated Sludge (RAS) / Waste Activated Sludge (WAS) concrete chamber
- SCADA and electrical works associated with the above.

The performance standards for final effluent have been set to ensure compliance with the Urban Waste Water Treatment Directive & associated Treatment Standards and to ensure

there is no significant adverse effect on the receiving aquatic environment, the Delvin River (Delvin_020).

The interim upgrade to the WwTP has been designed to meet the following proposed ELVs in **Table A.1.1** below:

Parameter	Unit	Proposed ELV
Biological Oxygen Demand (BOD)	mg/l	25
Chemical Oxygen Demand (COD)	mg/l	125
Suspended Solids (SS)	mg/l	35
Ammonia (as N)	mg/l	1.6
Ortho-phosphate (as P)	mg/l	1

The proposed ELVs have been set by IW to ensure that the operational discharges from the Naul agglomeration contribute towards achieving at least Good status in accordance with the European Union Environmental Objectives (Surface Waters) (Amendment). Regulations 2019 (S.I. No. 77 of 2019) and to assist in maintaining the current High status of Ammonium in the Delvin_020.

Refer **Section 2** above for details on the proposed discharges from the WwTP.

4. Description of the features and measures, if any, envisaged to avoid, prevent, or reduce and, if possible, offset the significant adverse effects on the environment

Secondary treatment with P and N removal will be provided at the upgrade WwTP to ensure that the treated effluent discharge does not have a significant adverse effect on the receiving aquatic environment, and that all relevant legislative requirements are complied with.

In terms of the Storm Water Overflow from the WwTP, SW002 will not meet the criteria as set out in the DoEHLG 'Procedures and Criteria in Relation to Storm Water Overflows', 1995. However, Irish Water are proposing a further upgrade to the works to increase capacity of the plant to 900 p.e. under the Small Towns & Villages Growth Programme (STVP) and the provision of a storm tank is likely to be progressed at that time subject to statutory and budgetary approvals. Any overflow from SW002 will be screened, and will be diluted due to the storm event, prior to discharging to the Delvin River.

The proposed ELVs as listed above give effect to the principle of the Combined Approach as defined in Waste Water Discharge (Authorisation) Regulations, 2007 to 2020 in that they accommodate the Urban Waste Water Regulations and the relevant status of the receiving waterbody, the Delvin River.

Irish Water are committed to ensuring that water services infrastructure operates in a manner that supports the achievement of the water body objectives under the Water Framework Directive, and their obligations under the Birds and Habitats Directives.

5. The proposed technology and other techniques for preventing or, where this is not possible, reducing discharges from the wastewater works

As noted above, the WwTP has been designed, and will be operated, to ensure the primary discharge of treated effluent (SW001) does not cause a significant adverse effect on the receiving environment *i.e.*, Delvin_020.

Any overflow from SW002 will be screened and will be diluted in nature due to the storm event, prior to discharging to the Delvin River. In terms of storm storage, Irish Water are proposing a further upgrade to the works to increase capacity of the plant to 900 p.e. under the Small Towns & Villages Growth Programme (STVP) and the provision of a storm tank is likely to be progressed at that time subject to statutory and budgetary approvals.

6. Description of the receiving waterbody

The Naul WwTP discharges to the Delvin River (Delvin_020). Delvin_020 is within the Nanny-Delvin Catchment (Hydrometric Area 08). The Delvin River has been classified by the EPA as having Moderate water quality under the Water Framework Directive (2013 – 2018) and is further assessed as being At Risk of not achieving Good water quality status during 2022-2027. Significant pressures for the Delvin_020 have been determined, within the draft 3rd cycle Catchment Report, as Agriculture, Hydromorphology and Mines and Quarries. Naul WwTP is not listed as a significant pressure.

The Delvin_020 waterbody trends (at the Br NW of Forty Acres station, downstream of the operational discharges) for Ortho-P for 2013-2018 are Upwards (increasing concentrations) while trends for Total Ammonia are downwards (decreasing concentrations), but both are not statistically significant. Ammonium is noted as High under WFD status. Ortho-P deteriorated in indicative quality from Poor to Bad from 2010-2015 to 2013-2018. However, Ortho-P is noted as Moderate under WFD status.

The EPA undertake biological monitoring of the Delvin River at various locations. Upstream of the WwTP at RS08D010080 (*ca.* 1.5 km upstream), the 2020 monitoring reported a Q value of 3 (Poor). Downstream of the WwTP at RS08D010250 (*ca.* 4 km downstream) the 2020 monitoring reported a Q value of 3-4 (Moderate).

Based on ambient monitoring results upstream and downstream of the current discharge for the period between January 2019 to Sept 2021, the mean concentration for BOD and Ammonia are within the required EQSs for Good and High status, respectively. In relation to Ortho-P, the mean upstream and downstream concentration was 0.0715 mg/l and 0.078mg/l respectively (mean Good Status EQS - 0.035mg/l), indicating that the EQS for Good status was not met upstream or downstream of the WwTP.

There are a number of designations within the wider surrounding environment (refer to **Attachment D.1: Map 8** - Receiving Water Designations). These are detailed below.

Balbriggan/Skerries designated shellfish area is *ca.* 10 km downstream of the Naul discharge location. The Sea Fisheries Protection Authority (July 2021) have assigned this classified shellfish area as Class A, the highest quality standard. Shellfish from A Classification areas can be taken for direct human consumption without further processing. The Marine Institute average dissolved concentrations for metals in shellfish waters for the period 2016-2019 and the microbial quality in shellfish flesh for 2018 were assessed within the draft 3rd cycle Catchment Report for the hydrometric area 08. This assessment determined the WFD protected area objective for shellfish areas are met.

There are no nutrient sensitive waters, drinking water abstraction points or freshwater pearl mussel designated habitats within the region of, or relevant to, the Naul agglomeration.

Whilst the Delvin River is not a Designated Salmonid Water under S.I. No. 293 of 1988, the stretches of the river below the town of Naul are suitable for a range of fish species including salmonids. Trout have also been angled along the watercourse.

The nearest European site is River Nanny Estuary and Shore SPA (004158) which is located along the coastline *ca.* 8.3 km north of the project site (*via* land). The River Nanny Estuary and Shore SPA is 1.8 km upstream of the mouth of the River Delvin. There is potential indirect connectivity through surface water features to this European site *via ca.* >10 km of the Delvin River and on through *ca.* 2 km of the Irish Sea. Whilst this potential connectivity exists, it is indirect and weak. There is 1 no. Natural Heritage Area (NHA) within 15 km of the development; Skerries Islands NHA is located *ca.* 13 km east of the WwTP. There are also 5 no. proposed Natural Heritage Areas (pNHA) within 15 km; Bog of the Ring pNHA is the closest at *ca.* 3.5 km east of the WwTP. However, there are no hydrological links between the operational discharges and any of the NHAs or pNHAs within 15 km of the WwTP.

7. Description of the likely significant effects of the discharges on the environment

The objective of the proposed upgrade works at the Naul WwTP is to increase the capacity of the plant to cater for 745 p.e. whilst also improving the treatment process (Nitrogen & Phosphorus removal).

Based on the proposed effluent discharge standards (see **Table A.1.1** above) and the WAC calculations carried out for same (see **Attachment D.2.3**), it is considered that the operational discharges from the Naul agglomeration would have no real likelihood of significant adverse effects on the receiving aquatic environment, alone or in combination with other plans and projects.

The proposed ELVs have been set by IW to ensure that the operational discharges from the Naul agglomeration contribute towards achieving at least Good status in accordance with the European Union Environmental Objectives (Surface Waters) (Amendment). Regulations 2019 (S.I. No. 77 of 2019) and maintaining the current High status of Ammonium in the Delvin _020.

8. Measures planned to monitor discharges into the environment

Effluent Monitoring:

It is proposed that the effluent monitoring will continue to be carried by Fingal Co. Co., on behalf of Irish Water, in line with any new licence requirements.

The proposed effluent monitoring regime is tabled below.

Table A.1.4 – Proposed Effluent Monitoring Regime

Parameter	Units	Monitoring Frequency	Analysis method/Technique
Flow	m ³ /s	Continuous	On-line flow meter with recorder
pH	pH Units	Weekly	pH Meter and recorder
Conductivity	µS/m	Bi-monthly	Conductivity Meter

Parameter	Units	Monitoring Frequency	Analysis method/Technique
cBOD	mg/l	Bi-monthly	Standard Method
COD	mg/l	Bi-monthly	Standard Method
Suspended Solids	mg/l	Bi-monthly	Standard Method
Ammonia (as N)	mg/l	Bi-monthly	Standard Method
Visual Inspection	Descriptive	Weekly	Sample and examine for colour and odour
Ortho-Phosphate (as P)	mg/l	Bi-monthly	Standard Method
Total Nitrogen	mg/l	Bi-monthly	Standard Method
Total Phosphorus	mg/l	Bi-monthly	Standard Method

Ambient Monitoring:

It is proposed that ambient monitoring and analysis will continue to be carried by Fingal Co. Co., on behalf of Irish Water, upstream and downstream of the primary discharge, in line with any new licence requirements.

The proposed monitoring locations and parameters to be monitored are tabled below. The monitoring locations have been selected based on Health and Safety grounds to ensure safe access during the collection of samples during the monitoring regime.

Table A.1.5 – Proposed Ambient Monitoring Locations and Parameters

Monitoring Location					Name of Receiving Water
311989	E	260676	N	Upstream aSWu	DELVIN_010
314364	E	263783	N	Downstream aSWd	DELVIN_020

Table A.1.6 – Proposed Ambient Monitoring Regime

Parameter	Units	Monitoring Frequency	Analysis method/Technique
pH	pH Unit	Quarterly	pH meter and recorder
BOD	mg/l	Quarterly	Standard Method
Suspended Solids	mg/l	Quarterly	Standard Method
DO	% O ₂	Quarterly	Electrode
DO	mg/l	Quarterly	Standard Method
Ortho-phosphate (as P)	mg/l	Quarterly	Standard Method
Ammonia (as N)	mg/l	Quarterly	Standard Method
Temperature	°C	Quarterly	Standard Method
Visual inspections	Descriptive	Weekly	Sample and examine for colour and odour

9. Hours during which the wastewater works is supervised or manned and days per week of this supervision

A caretaker will attend the plant on a daily basis and the hours spent each day at the plant will vary depending on various factors *e.g.*, weather or breakdowns in plant or maintenance works required such as cleaning of the intake screens etc.

10. In the event of a review application, state the grounds for which this review application is being made

Not applicable. Not a review application.

For inspection purposes only.
Consent of copyright owner required for any other use.

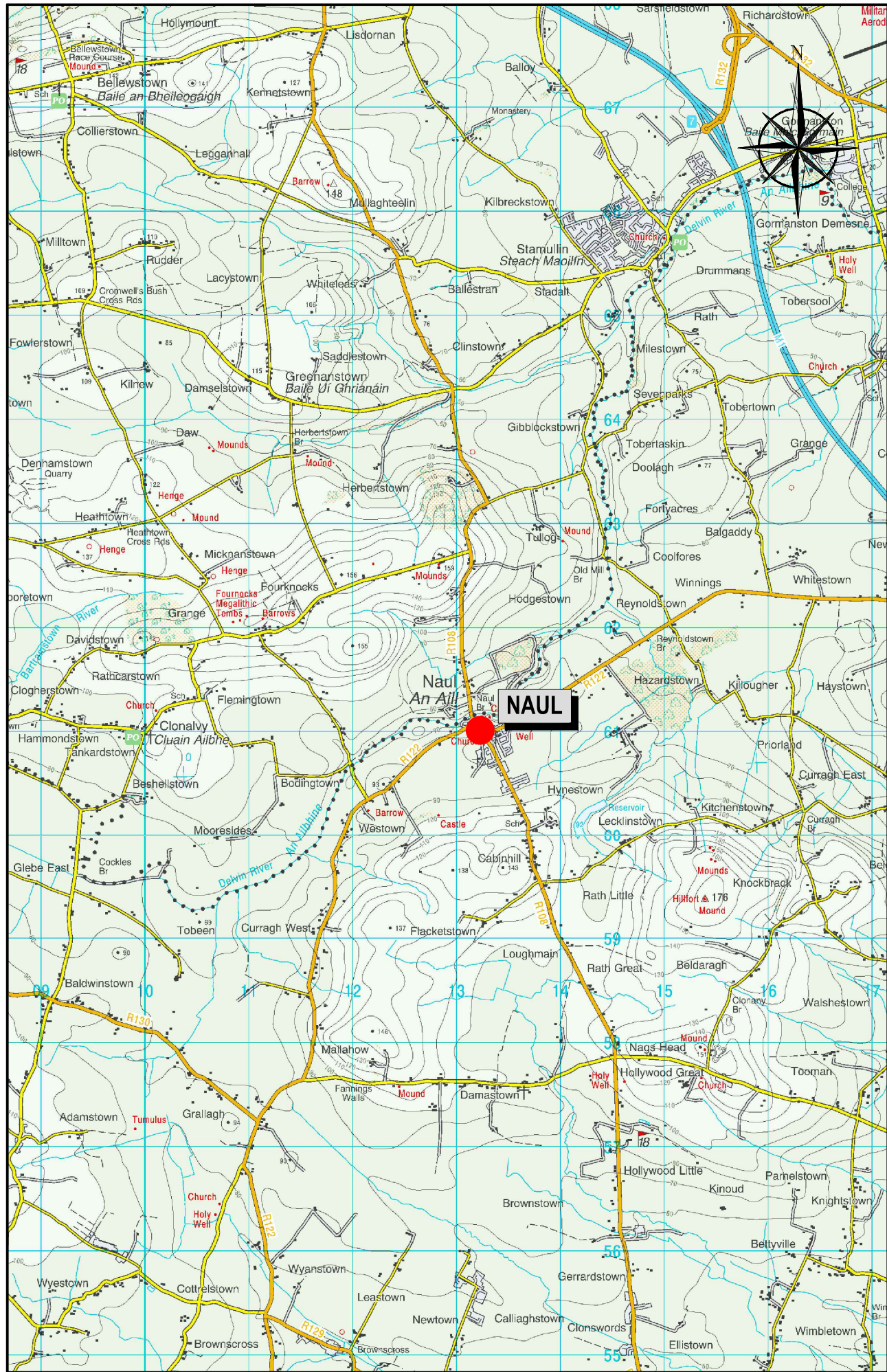

NAUL LOCATION MAP
SCALE 1:50,000

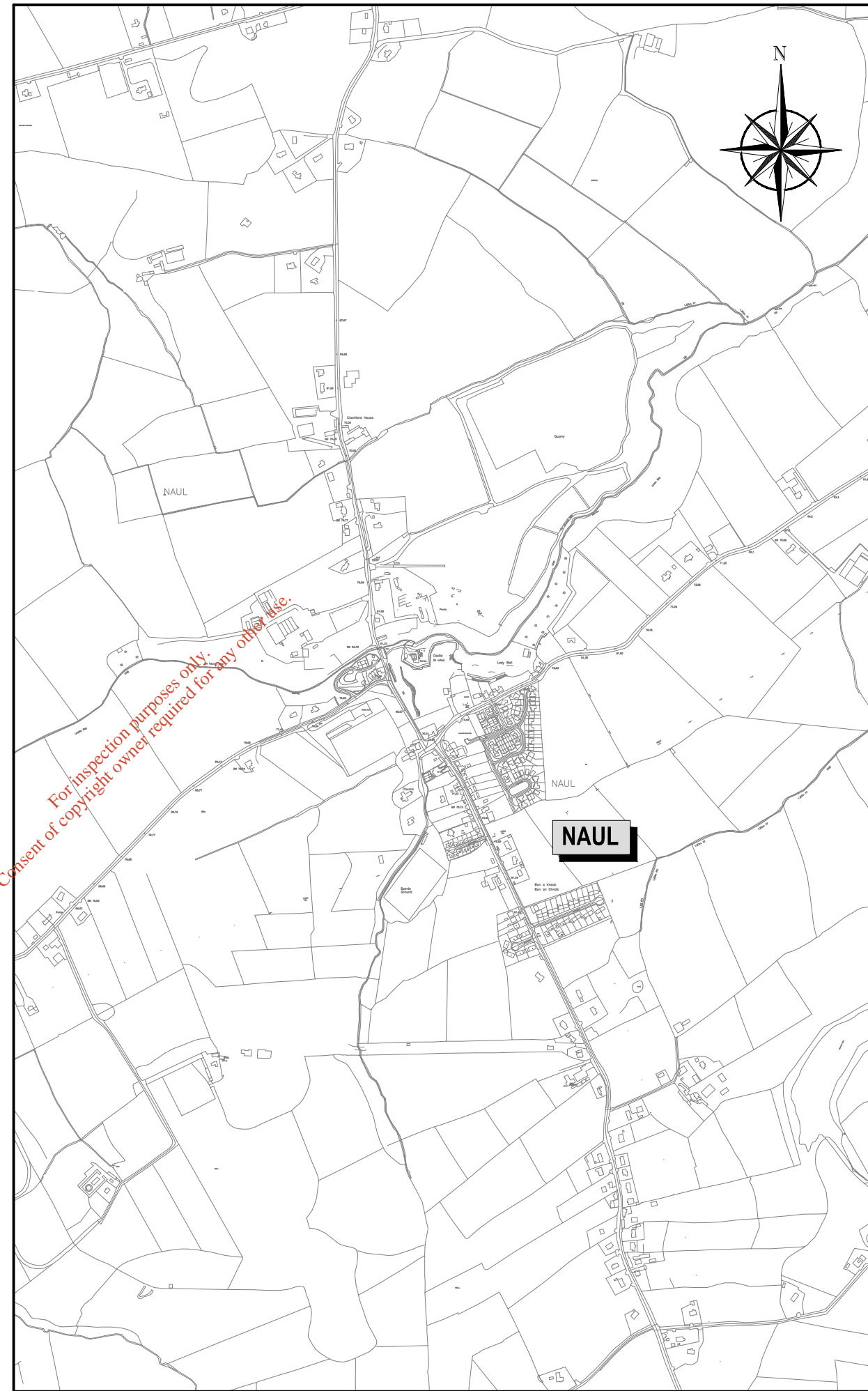

NAUL LOCATION PLAN
SCALE 1:12,500

NOTES
Ordnance Survey Ireland Licence No. EN0083316
Copyright Ordnance Survey Ireland / Government of Ireland.

SIGNED: _____
 PRINT NAME: _____
 POSITION: _____
 DATE: _____

FOR IRISH WATER

REV	DATE	DESCRIPTION	D	C	A

DISCHARGE LICENCE

CLIENT
 **IRISH WATER**
 Colvill House,
 24-26 Talbot Street,
 Dublin 1.
 Tel. 1890 278 278 Web. www.water.ie

PROJECT
NAUL
WASTE WATER DISCHARGE
LICENCE APPLICATION

TITLE
MAP 1
AREA OF INTEREST

SCALES	DRAWN	REV
AS SHOWN	D. Smithers	-
CAD REFERENCE	DATE	
20893-NOD-WWDL-01	30.11.2021	
ATTACHMENT		
A.1.1		



SECTION B: GENERAL

*For inspection purposes only.
Consent of copyright owner required for any other use.*

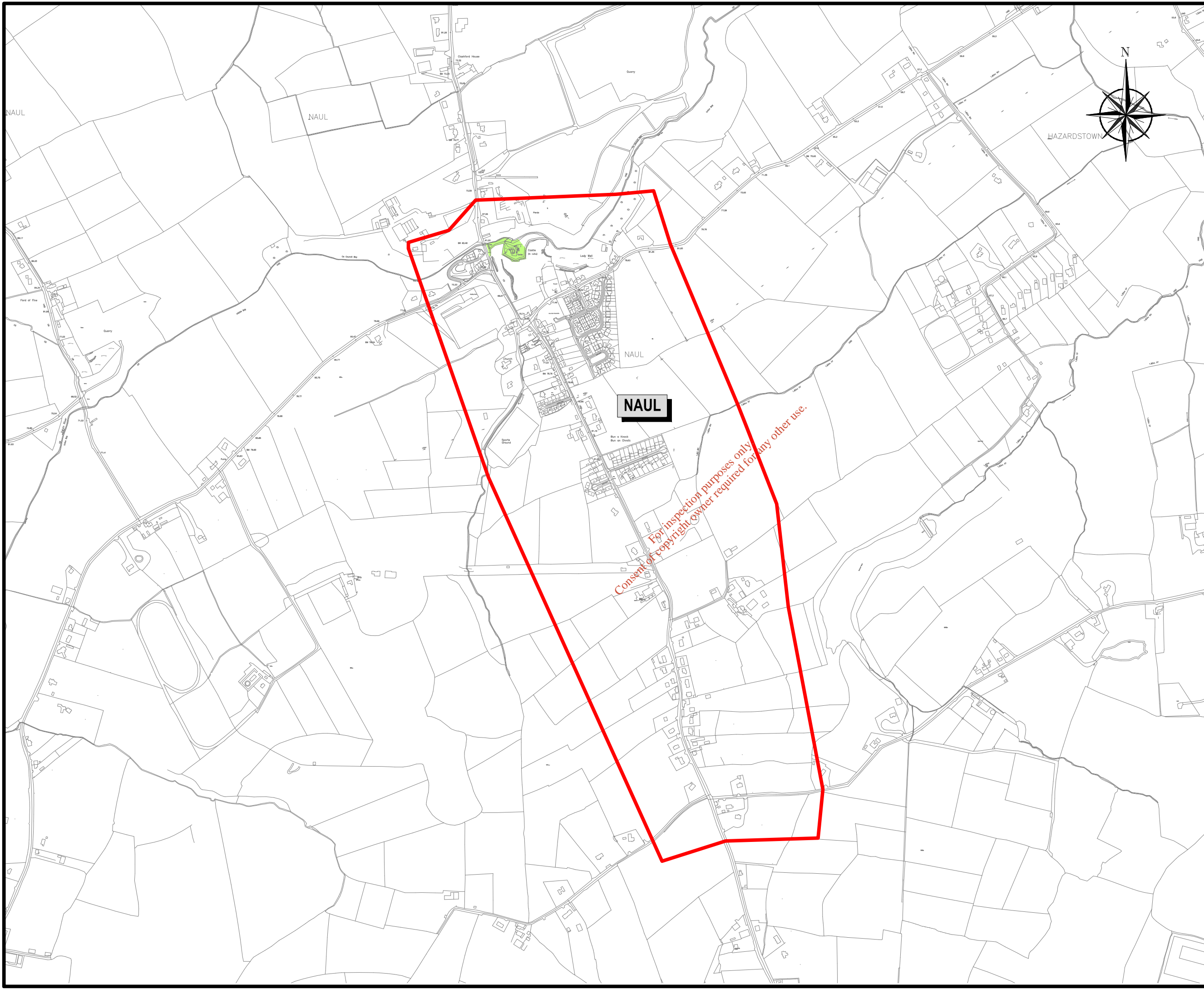

NOTES
 Ordnance Survey Ireland Licence No. EN0083316
 Copyright Ordnance Survey Ireland / Government of Ireland.

LEGEND

- AGGLOMERATION AREA
- WASTEWATER TREATMENT PLANT

SIGNED:
PRINT NAME:
POSITION:
DATE:
FOR IRISH WATER

REV	DATE	DESCRIPTION	D	C	A

DISCHARGE LICENCE







CLIENT
IRISH WATER
 Colvill House,
 24-26 Talbot Street,
 Dublin 1.
 Tel. 1890 278 278 Web. www.water.ie

PROJECT
**NAULL
 WASTE WATER DISCHARGE
 LICENCE APPLICATION**

TITLE
**MAP 2
 AGGLOMERATION PLAN**

SCALES 1:10,000	DRAWN D. Smithers	DATE 30.11.2021	
CAD REFERENCE 20893-NOD-WWDL-01	ATTACHMENT B.2.1	REV -	

LEGEND

-  WWTP SITE BOUNDARY
-  WASTE WATER PROCESS PIPELINES
-  OVERFLOW PIPELINE
-  OUTFALL PIPELINE
-  SW001 - PRIMARY DISCHARGE LOCATION
-  SW001(s) - PRIMARY DISCHARGE SAMPLING LOCATION

POINT	EASTING	NORTHING
SW001	313239	261155
SW001(s)	313242	261140

SIGNED : _____

PRINT NAME : _____

POSITION : _____

DATE : _____

FOR IRISH WATER

01. CSO CHAMBER
02. INLET SCREENS
03. CHEMICAL DOSING TANK
04. AERATION TANK
05. AIR BLOWERS
06. SLUDGE STORAGE TANK & SUPERNATANT DRAWOFF
07. SLUDGE (RAS / WAS) PUMP STATION
08. FINAL CLARIFIER TANK
09. FINAL EFFLUENT FLOW & SAMPLING CHAMBER
10. ADMINISTRATION BUILDING
11. CONTROL KIOSK

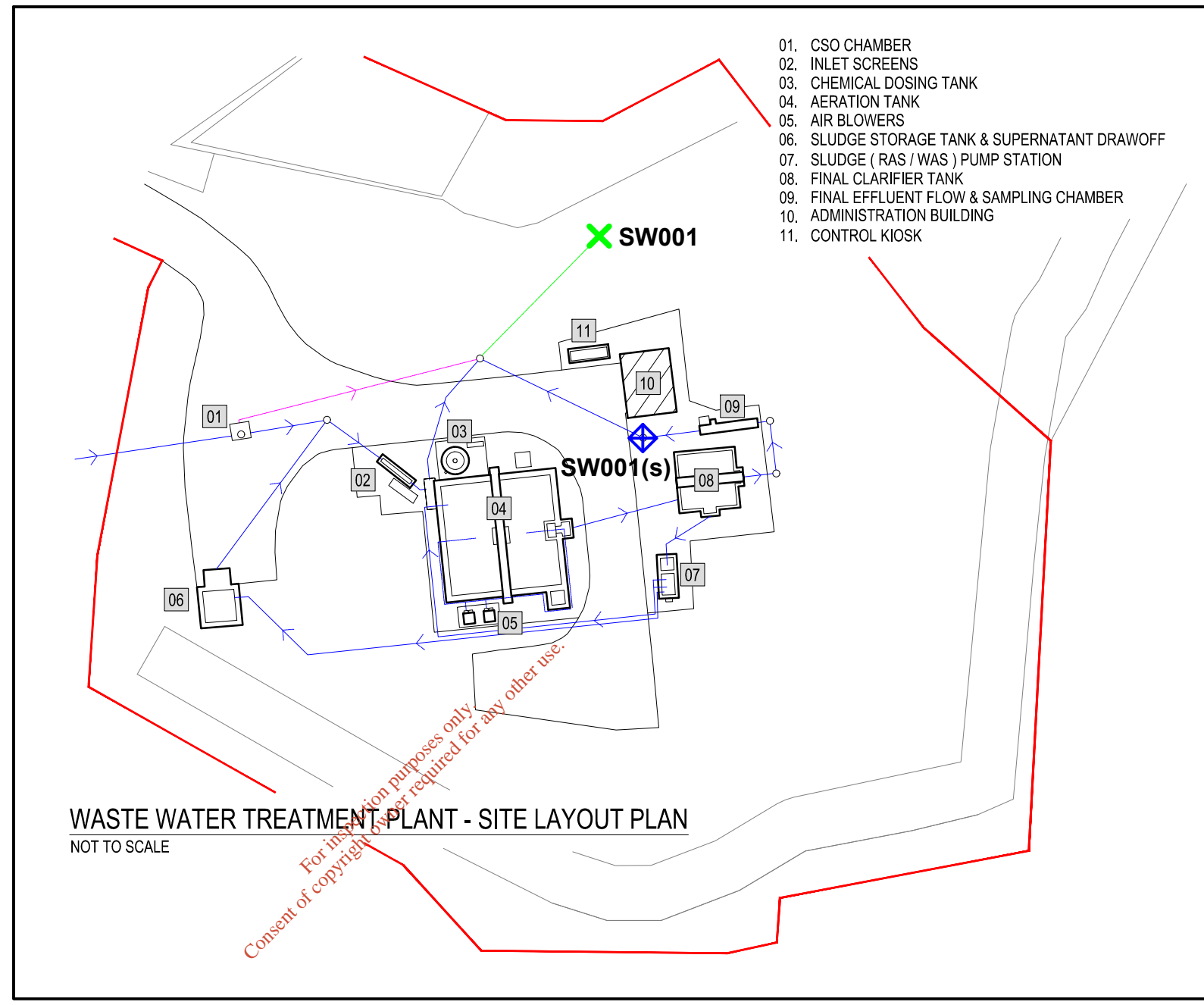

WASTE WATER TREATMENT PLANT - SITE LAYOUT PLAN
NOT TO SCALE



REV	DATE	DESCRIPTION	D	C	A

DISCHARGE LICENCE

CLIENT
 **IRISH WATER**
 Colvill House,
 24-26 Talbot Street,
 Dublin 1.
 Tel. 1890 278 278 Web. www.water.ie

PROJECT
NAULL
WASTE WATER DISCHARGE LICENCE APPLICATION

TITLE
MAP 3
WWTP SITE LOCATION PLAN

SCALES
 AS SHOWN

DRAWN
 D. Smithers

DATE
 30.11.2021

CAD REFERENCE
 20893-NOD-WWDL-01

ATTACHMENT
B.2.2

REV
 -

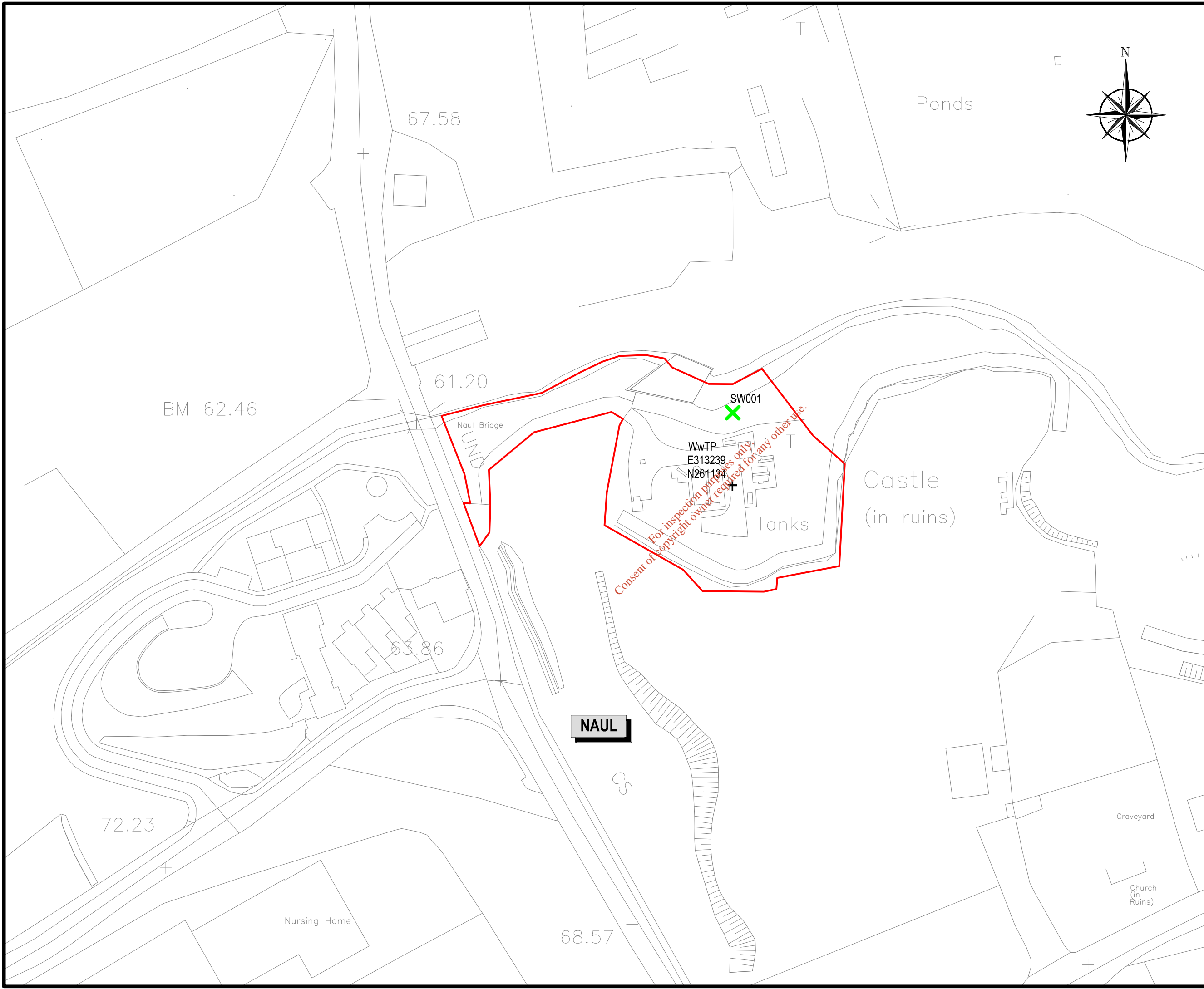

NOTES
 Ordnance Survey Ireland Licence No. EN0083316
 Copyright Ordnance Survey Ireland / Government of Ireland.

- LEGEND**
- ⬡ WwTP SITE BOUNDARY
 - ✕ SW001 - PRIMARY DISCHARGE LOCATION

POINT	EASTING	NORTHING
SW001	313239	261155

SIGNED: _____

PRINT NAME: _____

POSITION: _____

DATE: _____

FOR IRISH WATER

REV	DATE	DESCRIPTION	D	C	A

DISCHARGE LICENCE

CLIENT
IRISH WATER
 Colvill House,
 24-26 Talbot Street,
 Dublin 1.
 Tel. 1890 278 278 Web. www.water.ie

PROJECT
**NAUL
 WASTE WATER DISCHARGE
 LICENCE APPLICATION**

TITLE
**MAP 4
 LOCATION OF
 PRIMARY DISCHARGE POINT**

SCALES
 1:1,000

DRAWN
 D. Smithers

DATE
 30.11.2021

CAD REFERENCE
 20893-NOD-WWDL-01

ATTACHMENT
B.2.2

REV
 -

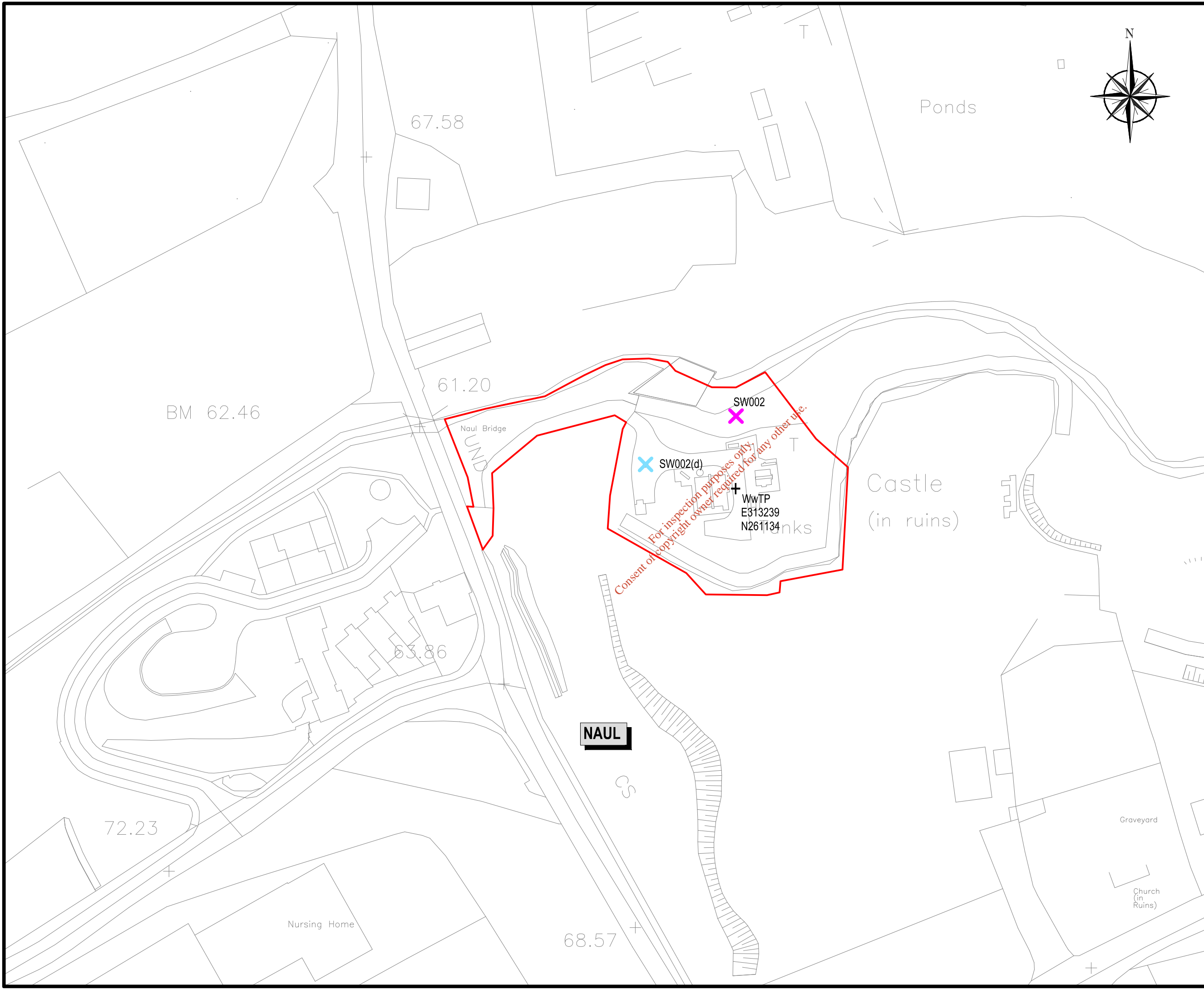

NOTES
 Ordnance Survey Ireland Licence No. EN0083316
 Copyright Ordnance Survey Ireland / Government of Ireland.

- LEGEND**
- WWTP SITE BOUNDARY
 - X SW002, STORM WATER OVERFLOW
 - X SW002(d), STORM WATER OVERFLOW DEVICE LOCATION

POINT	EASTING	NORTHING
SW002	313239	261155
SW002(d)	313212	261141

For inspection purposes only.
 Consent of copyright owner required for any other use.

SIGNED : _____

PRINT NAME : _____

POSITION : _____

DATE : _____

FOR IRISH WATER

REV	DATE	DESCRIPTION	D	C	A

DISCHARGE LICENCE

CLIENT
IRISH WATER
 Colvill House,
 24-26 Talbot Street,
 Dublin 1.
 Tel. 1890 278 278 Web. www.water.ie

PROJECT
**NAUL
 WASTE WATER DISCHARGE
 LICENCE APPLICATION**

TITLE
**MAP 5
 LOCATION OF
 STORM WATER OVERFLOW**

SCALES 1:1,000	DRAWN D. Smithers	DATE 30.11.2021
CAD REFERENCE 20893-NOD-WWDL-01	ATTACHMENT B.2.2	REV -



NOTES
 Ordnance Survey Ireland Licence No. EN0083316
 Copyright Ordnance Survey Ireland / Government of Ireland.

LEGEND
 WWTP SITE LOCATION
 aSWx - AMBIENT MONITORING LOCATION

POINT	EASTING	NORTHING
aSWu	311989	260676
aSWd	314364	263783

SIGNED : _____
 PRINT NAME : _____
 POSITION : _____
 DATE : _____
 FOR IRISH WATER

REV	DATE	DESCRIPTION	D	C	A

DISCHARGE LICENCE

CLIENT
IRISH WATER
 Cahill House,
 24-26 Talbot Street,
 Dublin 1.
 Tel. 1890 278 278 Web. www.water.ie

PROJECT
NAULL
WASTE WATER DISCHARGE
LICENCE APPLICATION

TITLE
MAP 6
LOCATION OF
AMBIENT MONITORING POINTS

SCALES
 1:12,500
 DRAWN
 D. Smithers
 DATE
 30.11.2021

CAD REFERENCE
 20893-NOD-WWDL-01
 ATTACHMENT
B.2.2
 REV
 -

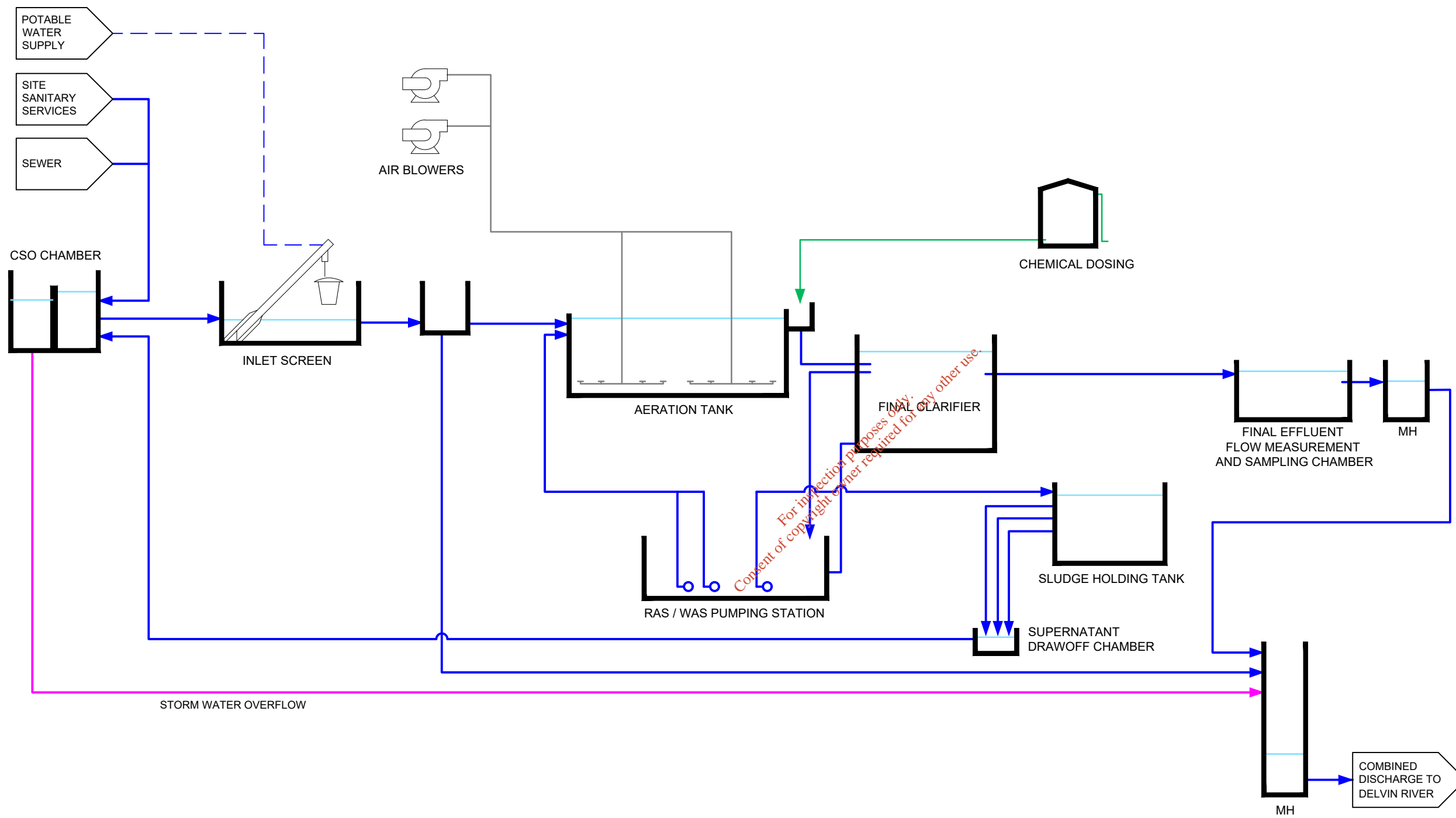

For inspection purposes only. Content of copyright owner required for any other use.

NOTES

SIGNED : _____
 PRINT NAME : _____
 POSITION : _____
 DATE : _____
 FOR IRISH WATER

REV	DATE	DESCRIPTION	D	C	A

DISCHARGE LICENCE

CLIENT
IRISH WATER
 Colvill House,
 24-26 Talbot Street,
 Dublin 1.
 Tel. 1890 278 278 Web. www.water.ie

PROJECT
**NAUL
 WASTEWATER DISCHARGE
 LICENCE APPLICATION**

TITLE
**WASTE WATER
 PROCESS FLOW DIAGRAM**

SCALES N.T.S.	DRAWN D. Smithers
CAD REFERENCE 20893-NOD-WWDL-01	DATE 30.11.2021
ATTACHMENT B.2.3	REV -



ATTACHMENT B.4: NOTICES AND ADVERTISEMENTS

*For inspection purposes only.
Consent of copyright owner required for any other use.*

For inspection purposes only.
Consent of copyright owner required for any other use.

PUBLIC NOTICE

Application to the Environmental Protection Agency for a Waste Water Discharge Licence



Pursuant to Regulation 9 of the European Union (Waste Water Discharge) Regulations 2007 to 2020, Irish Water, Colvill House, 24-26 Talbot Street, Dublin 1, intend to apply to the Environmental Protection Agency for a Waste Water Discharge Licence for the Naul Waste Water Treatment Works, Naul, Co. Dublin. The waste water works consists of a Waste Water Treatment Plant at Naul Townland, 31 3239E, 261 1 34N, a primary discharge (SW001) and a Storm Water Overflow (SW002) which discharge into the Delvin River.

Waste Water Works Item	Location	Irish National Grid Reference
Waste Water Treatment Plant	Naul	313239E, 261134N
Primary Discharge (SW001)	Naul	313239E, 261155N
Storm Water Overflow (SW002)	Naul	313239E, 261155N

A copy of -

- (i) The application for a waste water discharge licence
- (ii) Such further information relating to the application as may be furnished to the Agency in the course of the Agency's consideration of the application

shall, as soon as is practicable after receipt by the Agency, be available for inspection or purchase at a fee not exceeding the reasonable cost of making a copy at the headquarters of the Environmental Protection Agency, P.O. Box 3000, Johnstown Castle Estate, Co. Wexford; at Irish Water, Colvill House, 24-26 Talbot Street, Dublin 1 and at Fingal County Council, County Hall, Main Street, Swords, Co Dublin.

Submissions in relation to the review application may be made to the Environmental Protection Agency at its headquarters at P.O. Box 3000, Johnstown Castle Estate, Co. Wexford, in writing within the period of 5 weeks beginning on the date of receipt by the Agency of the application.



PUBLIC NOTICE

APPLICATION TO THE ENVIRONMENTAL PROTECTION AGENCY FOR THE OF A WASTE WATER DISCHARGE LICENCE

Pursuant to Regulation 9 of the European Union (Waste Water Discharge) Regulations 2007 to 2020, Irish Water, Colvill House, 24-26 Talbot Street, Dublin 1, intend to apply to the Environmental Protection Agency for a Waste Water Discharge Licence for the Naul Waste Water Treatment Works, Naul, Co. Dublin. The waste water works consists of a Waste Water Treatment Plant at Naul Townland, 313239E, 261134N, a primary discharge (SW001) and a Storm Water Overflow (SW002) which discharge into the Delvin River. Details of the location of these works and associated discharges are as follows:-

Waste Water Works Item	Location	Irish National Grid Reference
Waste Water Treatment Plant	Naul	313239E, 261134N
Primary Discharge (SW001)	Naul	313239E, 261155N
Storm Water Overflow (SW002)	Naul	313239E, 261155N

A copy of –

- (i) The application for a waste water discharge licence
- (ii) Such further information relating to the application as may be furnished to the Agency in the course of the Agency's consideration of the application

shall, as soon as is practicable after receipt by the Agency, be available for inspection or purchase at a fee not exceeding the reasonable cost of making a copy at the headquarters of the Environmental Protection Agency, P.O. Box 3000, Johnstown Castle Estate, Co. Wexford; at Irish Water, Colvill House, 24-26 Talbot Street, Dublin 1 and at Fingal County Council, County Hall, Main Street, Swords, Co Dublin.

Submissions in relation to the review application may be made to the Environmental Protection Agency at its headquarters at P.O. Box 3000, Johnstown Castle Estate, Co. Wexford, in writing within the period of 5 weeks beginning on the date of receipt by the Agency of the application.

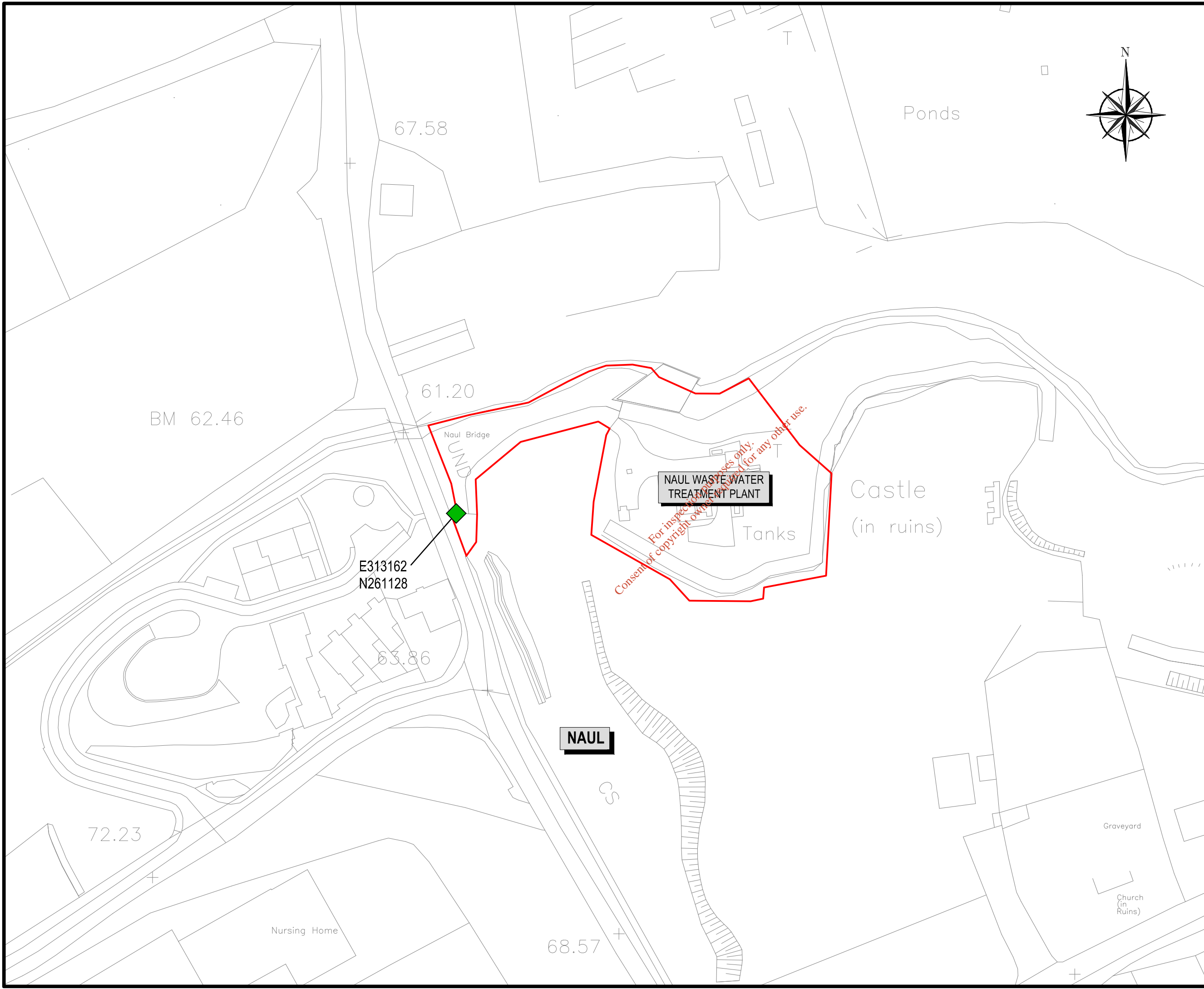

NOTES
 Ordnance Survey Ireland Licence No. EN0083316
 Copyright Ordnance Survey Ireland / Government of Ireland.

LEGEND

- WWTP SITE BOUNDARY
- SITE NOTICE LOCATION

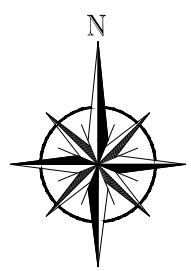

SIGNED: _____

PRINT NAME: _____

POSITION: _____

DATE: _____

FOR IRISH WATER

REV	DATE	DESCRIPTION	D	C	A

DISCHARGE LICENCE

CLIENT
IRISH WATER
 Colvill House,
 24-26 Talbot Street,
 Dublin 1.
 Tel. 1890 278 278 Web. www.water.ie

PROJECT
**NAUL
 WASTE WATER DISCHARGE
 LICENCE APPLICATION**

TITLE
**MAP 7
 SITE NOTICE LOCATION**

SCALES
 1:1,000

DRAWN
 D. Smithers

DATE
 30.11.2021

CAD REFERENCE
 20893-NOD-WWDL-01

ATTACHMENT
B.4.3

REV
 -



ATTACHMENT B.5: PRELIMINARY EIA SCREENING REPORT

*For inspection purposes only.
Consent of copyright owner required for any other use.*

**Naul Agglomeration – Operational Discharges
Preliminary EIA Screening**

	Comment:	Yes/No/ Uncertain:
<p>Nature of the Activity <i>Is the nature of the proposed activity exceptional in the context of the existing environment?</i></p> <p><i>Will the activity result in the production of any significant emissions or pollutants?</i></p>	<p>The population equivalent (p.e) to which this application relates is 754 which is significantly below the 10,000 p.e mandatory threshold for EIA.</p> <p>The Naul agglomeration is a small catchment area currently serving 674 p.e. with a maximum p.e. of 745.</p> <p>The source of the wastewater in the agglomeration is largely domestic in nature which is readily biodegradable.</p> <p>Based on the proposed effluent discharge standards and WAC calculations carried out for same, it is considered that the operational discharges from the Naul agglomeration would have no real likelihood of significant effects on the environment, alone or in combination with other plans and projects.</p>	No
<p>Size of the Activity: <i>Is the size of the activity (i.e., operational discharges) exceptional in the context of the existing environment?</i></p> <p><i>Are there cumulative considerations having regard to other existing and/or permitted projects?</i></p>	<p>The Naul agglomeration is a small catchment area currently serving 674 p.e. with a maximum p.e. of 745 after the WwTP upgrade.</p> <p>It is considered due to the size of the agglomeration and the associated proposed operational discharges that there would be no real likelihood of significant effects on the environment, alone or in combination with other plans and projects.</p>	No
<p>Location: <i>Is the activity located on, in, adjoining or does it have the potential to impact on an ecologically sensitive site or location?¹</i></p> <p><i>Does the activity have the potential to affect other significant environmental sensitivities in the area?</i></p>	<p>The nearest European site is River Nanny Estuary and Shore SPA (004158) which is located along the coastline <i>ca.</i> 8.3 km north of the project site (<i>via</i> land). The River Nanny Estuary and Shore SPA is 1.8 km upstream of the mouth of the River Delvin. There is potential indirect connectivity through surface water features to this European site <i>via ca.</i> >10 km of the Delvin River and on through <i>ca.</i> 2 km of the Irish Sea. Whilst this potential connectivity exists, it is indirect and weak. There is 1 no. Natural Heritage Area (NHA) within 15 km of the development; Skerries Islands NHA is located <i>ca.</i> 13 km east of the site. There are also 5 no. proposed Natural Heritage Areas (pNHA) within 15 km; Bog of the Ring pNHA is the closest at <i>ca.</i> 3.5 km east of the site. However, there are no hydrological links between the operational</p>	No

¹ Sensitive locations or features includes European sites, NHA/pNHA, Designated Nature Reserves, land designated as a refuge for flora and fauna, and any other ecological site which is the objective of a CDP/LAP (including draft plans).

	<p>discharges and any of the NHAs or pNHAs within 15 km of the WwTP.</p> <p>In terms of location and based on the above it is considered that the operational discharges from the Naul agglomeration would have no real likelihood of significant effects on the environment, alone or in combination with other plans and projects.</p>	
--	--	--

Preliminary EIA Screening Conclusion:

Based on a preliminary EIA screening examination of the **nature, size or location** of the operational discharges: *(Tick as appropriate)*

<input checked="" type="checkbox"/>	<input type="checkbox"/>	<input type="checkbox"/>
<p>There is no real likelihood of significant effects on the environment.</p> <p>EIA is not required.</p>	<p>There is real likelihood of significant effects on the environment.</p> <p>An EIAR is required.</p>	<p>There is significant and realistic doubt regarding the likelihood of significant effects on the environment.</p> <p>Request the applicant to submit the Information specified in Schedule 7A for the purposes of a screening determination.</p> <p>Proceed to Screening Determination.</p>

Preliminary EIA Screening Summary

The subject matter of this application (*i.e.*, operational discharges from the Naul agglomeration) falls well below the threshold of Regulation 17 (j) of S.I No. 214 of 2020 and is not a WwTP specified in accordance with paragraph (6)(c) or (8)(b)(ii) of Regulation 18 or paragraph (3)(c) or (5)(b)(ii) of Regulation 25.

Based on the above, it can be confidently concluded that the subject matter of this application, due to its size, scale, location, and nature, would have no real likelihood of significant effects on the environment, and therefore an Environmental Impact Assessment (EIA) and the production of an Environmental Impact Assessment Report (EIAR) is not required to support this application.

**Naul Agglomeration – Operational Discharges
Preliminary EIA Screening**

	Comment:	Yes/No/ Uncertain:
<p>Nature of the Activity <i>Is the nature of the proposed activity exceptional in the context of the existing environment?</i></p> <p><i>Will the activity result in the production of any significant emissions or pollutants?</i></p>	<p>The population equivalent (p.e) to which this application relates is 754 which is significantly below the 10,000 p.e mandatory threshold for EIA.</p> <p>The Naul agglomeration is a small catchment area currently serving 674 p.e. with a maximum p.e. of 745.</p> <p>The source of the wastewater in the agglomeration is largely domestic in nature which is readily biodegradable.</p> <p>Based on the proposed effluent discharge standards and WAC calculations carried out for same, it is considered that the operational discharges from the Naul agglomeration would have no real likelihood of significant effects on the environment, alone or in combination with other plans and projects.</p>	No
<p>Size of the Activity: <i>Is the size of the activity (i.e., operational discharges) exceptional in the context of the existing environment?</i></p> <p><i>Are there cumulative considerations having regard to other existing and/or permitted projects?</i></p>	<p>The Naul agglomeration is a small catchment area currently serving 674 p.e. with a maximum p.e. of 745 after the WwTP upgrade.</p> <p>It is considered due to the size of the agglomeration and the associated proposed operational discharges that there would be no real likelihood of significant effects on the environment, alone or in combination with other plans and projects.</p>	No
<p>Location: <i>Is the activity located on, in, adjoining or does it have the potential to impact on an ecologically sensitive site or location?¹</i></p> <p><i>Does the activity have the potential to affect other significant environmental sensitivities in the area?</i></p>	<p>The nearest European site is River Nanny Estuary and Shore SPA (004158) which is located along the coastline <i>ca.</i> 8.3 km north of the project site (<i>via</i> land). The River Nanny Estuary and Shore SPA is 1.8 km upstream of the mouth of the River Delvin. There is potential indirect connectivity through surface water features to this European site <i>via ca.</i> >10 km of the Delvin River and on through <i>ca.</i> 2 km of the Irish Sea. Whilst this potential connectivity exists, it is indirect and weak. There is 1 no. Natural Heritage Area (NHA) within 15 km of the development; Skerries Islands NHA is located <i>ca.</i> 13 km east of the site. There are also 5 no. proposed Natural Heritage Areas (pNHA) within 15 km; Bog of the Ring pNHA is the closest at <i>ca.</i> 3.5 km east of the site. However, there are no hydrological links between the operational</p>	No

¹ Sensitive locations or features includes European sites, NHA/pNHA, Designated Nature Reserves, land designated as a refuge for flora and fauna, and any other ecological site which is the objective of a CDP/LAP (including draft plans).

	<p>discharges and any of the NHAs or pNHAs within 15 km of the WwTP.</p> <p>In terms of location and based on the above it is considered that the operational discharges from the Naul agglomeration would have no real likelihood of significant effects on the environment, alone or in combination with other plans and projects.</p>	
--	--	--

Preliminary EIA Screening Conclusion:

Based on a preliminary EIA screening examination of the **nature, size or location** of the operational discharges: *(Tick as appropriate)*

<input checked="" type="checkbox"/> <p>There is no real likelihood of significant effects on the environment.</p> <p>EIA is not required.</p>	<input type="checkbox"/> <p>There is real likelihood of significant effects on the environment.</p> <p>An EIAR is required.</p>	<input type="checkbox"/> <p>There is significant and realistic doubt regarding the likelihood of significant effects on the environment.</p> <p>Request the applicant to submit the Information specified in Schedule 7A for the purposes of a screening determination.</p> <p>Proceed to Screening Determination.</p>
--	---	--

Preliminary EIA Screening Summary

The subject matter of this application (*i.e.*, operational discharges from the Naul agglomeration) falls well below the threshold of Regulation 17 (j) of S.I No. 214 of 2020 and is not a WwTP specified in accordance with paragraph (6)(c) or (8)(b)(ii) of Regulation 18 or paragraph (3)(c) or (5)(b)(ii) of Regulation 25.

Based on the above, it can be confidently concluded that the subject matter of this application, due to its size, scale, location, and nature, would have no real likelihood of significant effects on the environment, and therefore an Environmental Impact Assessment (EIA) and the production of an Environmental Impact Assessment Report (EIAR) is not required to support this application.



SECTION C: DISCHARGES & MONITORING

*For inspection purposes only.
Consent of copyright owner required for any other use.*



Waste Water Discharge Authorisation

Attachment C.1 – Discharges & Monitoring

Applicant Name:*

Naul

Application I.D.:*

TBC

For inspection purposes only.
Consent of copyright owner required for any other use.

SECTION C: DISCHARGES & MONITORING

This part of the application form collects information on the existing and proposed waste water discharges from the waste water works serving the agglomeration including proposed emission levels and monitoring results.

Section C.1 Discharges & Monitoring

Table C.1(a) - Primary waste water discharge (complete the table for existing and proposed primary discharge where relevant)

Primary Waste Water Discharge						
EDEN Code (where applicable)	Unique Point Code	Discharge Location	Monitoring Location	Receiving Water Name	WFD Code Receiving Water	Type of Receiving Water
Not Available as new WWDL application	SW001	313239E, 261155N	313242E, 261140N	Delvin River	DELVIN_020, IE_EA_08D010250	River

For inspection purposes only. Consent of copyright owner required for any other use.

Continued on next page.

Discharges Emission Levels and Monitoring – Proposed ELVs & Monitoring							
Discharges					Monitoring		
Parameter	Units	Interim emission level (or Interim % Reduction)	Proposed emission level	Emission level commencement date	Monitoring Frequency	Sampling Method	Analysis method/Technique
Flow	m ³ /s	-	-	-	Continuous	Composite	On-line flow meter with recorder
pH	pH Units	-	6-9	-	Weekly	Composite	pH Meter and recorder
Conductivity	µS/m	-	-	-	Bi-monthly	Composite	Conductivity Meter
cBOD	mg/l	-	25	-	Bi-monthly	Composite	Standard Method
COD	mg/l	-	125	-	Bi-monthly	Composite	Standard Method
Suspended Solids	mg/l	-	35	-	Bi-monthly	Composite	Standard Method
Ammonia (as N)	mg/l	-	1.6	-	Bi-monthly	Composite	Standard Method
Visual Inspection	Descriptive	-	-	-	Weekly	Grab	Sample and examine for colour and odour
Ortho-Phosphate (as P)	mg/l	-	1	-	Bi-monthly	Composite	Standard Method

For inspection purposes only. Consent of copyright owner required for any other use.

Discharges Emission Levels and Monitoring – Proposed ELVs & Monitoring							
Discharges					Monitoring		
Parameter	Units	Interim emission level (or Interim % Reduction)	Proposed emission level	Emission level commencement date	Monitoring Frequency	Sampling Method	Analysis method/Technique
Total Nitrogen	mg/l		-	-	Bi-monthly	Composite	Standard Method
Total Phosphorus	mg/l	-	-	-	Bi-monthly	Composite	Standard Method

For inspection purposes only.
Consent of copyright owner required for any other use.

Secondary Waste Water Discharge

Is a Secondary discharge associated with the agglomeration?	No
---	----

If yes, complete the following table for each secondary waste water discharge.

Table C.1(b) - Secondary waste water discharge

Secondary Waste Water Discharge							
EDEN Code (where applicable)	Unique point Code	Discharge Location	Monitoring Location	Receiving Water Name	WFD Code Receiving Water	Type of Receiving Water	Decommissioning date if applicable
Not applicable							

For inspection purposes only. Consent of copyright owner required for any other use.

Continued on next page.

Discharges Emission Levels and Monitoring							
Discharges					Monitoring		
Parameter	Units	Interim emission level (or Interim % Reduction)	Proposed emission level	Emission level commencement date	Monitoring Frequency	Sampling Method	Analysis method/Technique
Not applicable							

For inspection purposes only.
 Consent of copyright owner required for any other use.

Waste water discharges from Stormwater Overflows

Are discharges from storm water overflows associated with the agglomeration?	Yes
--	-----

If yes, complete the following table for waste water discharges from storm water overflows.

Table C.1(c) - Storm Water Overflows (additional rows may be added as required)

Storm Water Overflow (SWO)							
EDEN Code (Where available)	Unique Code	Discharge Location (6E, 6N)	SWO Location (6E, 6N)	Name of Receiving Water	WFD Code Receiving Water	Compliant * (Y/N)	Decommissioning date (where applicable)
Not Available as new WWDL application	SW002	313239E, 261155N	313212E, 261141N	Delvin River	DELVIN_020, IE_EA_08D010250	N**	N/A

* compliant with the criteria as set out in the DoEHLG ‘Procedures and Criteria in Relation to Storm Water Overflows’, 1995

** SW002 at the upgraded WwTP will not meet the criteria as set out in the DoEHLG ‘Procedures and Criteria in Relation to Storm Water Overflows’, 1995. However, Irish Water are proposing a further upgrade to the works to increase capacity of the plant to 900 p.e. under the Small Towns & Villages Growth Programme (STVP), and the provision of a storm tank is likely to be progressed under the IWSS or the STVP programme subject to statutory and budgetary approvals.

Emergency Overflow Point(s)

Are discharges from emergency overflows associated with the agglomeration?	No
--	----

If yes, complete the following table for waste water discharges from an emergency overflow.

Table C.1 (d) - Emergency Overflow (additional rows may be added as required)

Emergency Overflow Point					
Name of pumping station	Unique point code	Discharge Location (6E, 6N)	Emergency Overflow Location (6E, 6N)	Name of Receiving Water	WFD Code of Receiving Water

For inspection purposes only. Consent of copyright owner required for any other use.

Waste water treatment plant monitoring data

In the case of an existing associated waste water treatment plant(s), provide a summary of the sampling data pertaining to the discharge based on the samples taken in the 12 months preceding the making of the application by completing the following table.

Table C.1(e) - Effluent monitoring results – Bi-annual samples as per CoA A0103-01 (2020-2021 data)













Parameter:	pH pH units	cBOD mg/l	COD mg/l	SS mg/l	Dissolved Inorganic Nitrogen mg/l	Total Nitrogen mg/l	Total Phosphorous mg/l	Ammonia mg/l	Ortho-Phosphate mg/l	Nitrite mg/l	Nitrate mg/l	Conductivity µS/m	TON (mg/l)
Number of Samples:	4	4	4	4	4	4	4	4	4	4	4	4	4
Max result:	7.8	12	48	17	36.21	38	1.33	36.05	0.98	0.238	5.69	1005	5.86
Min result:	7.5	4	29	6	13.93	14.7	1.29	10.59	0.77	0.074	0.045	685	0.15
Average result	7.63	7.25	40.25	11.5	23.815	25.475	1.3075	21.5625	0.895	0.141	2.095	806.25	2.2525
Number of exceedances of ELV:	N/A	N/A	N/A	N/A	N/A	N/A	N/A	N/A	N/A	N/A	N/A	N/A	N/A
Overall compliance: (%)	N/A	N/A	N/A	N/A	N/A	N/A	N/A	N/A	N/A	N/A	N/A	N/A	N/A



SECTION D: IMPACT ASSESSMENT

*For inspection purposes only.
Consent of copyright owner required for any other use.*

Map 8 - Receiving Water Designations

-  Discharge Points from WwTP
 -  Naul Agglomeration Boundary
 -  SPA
 -  SAC
 -  pNHA
 -  Designated Shellfish Waters
-
- WFD Coastal Waterbody Status**
-  High
 -  Unassigned
-
- WFD Transitional Waterbody Status**
-  Bad
 -  Unassigned
-
- WFD River Waterbody Status**
-  Unassigned
 -  Poor
 -  Moderate

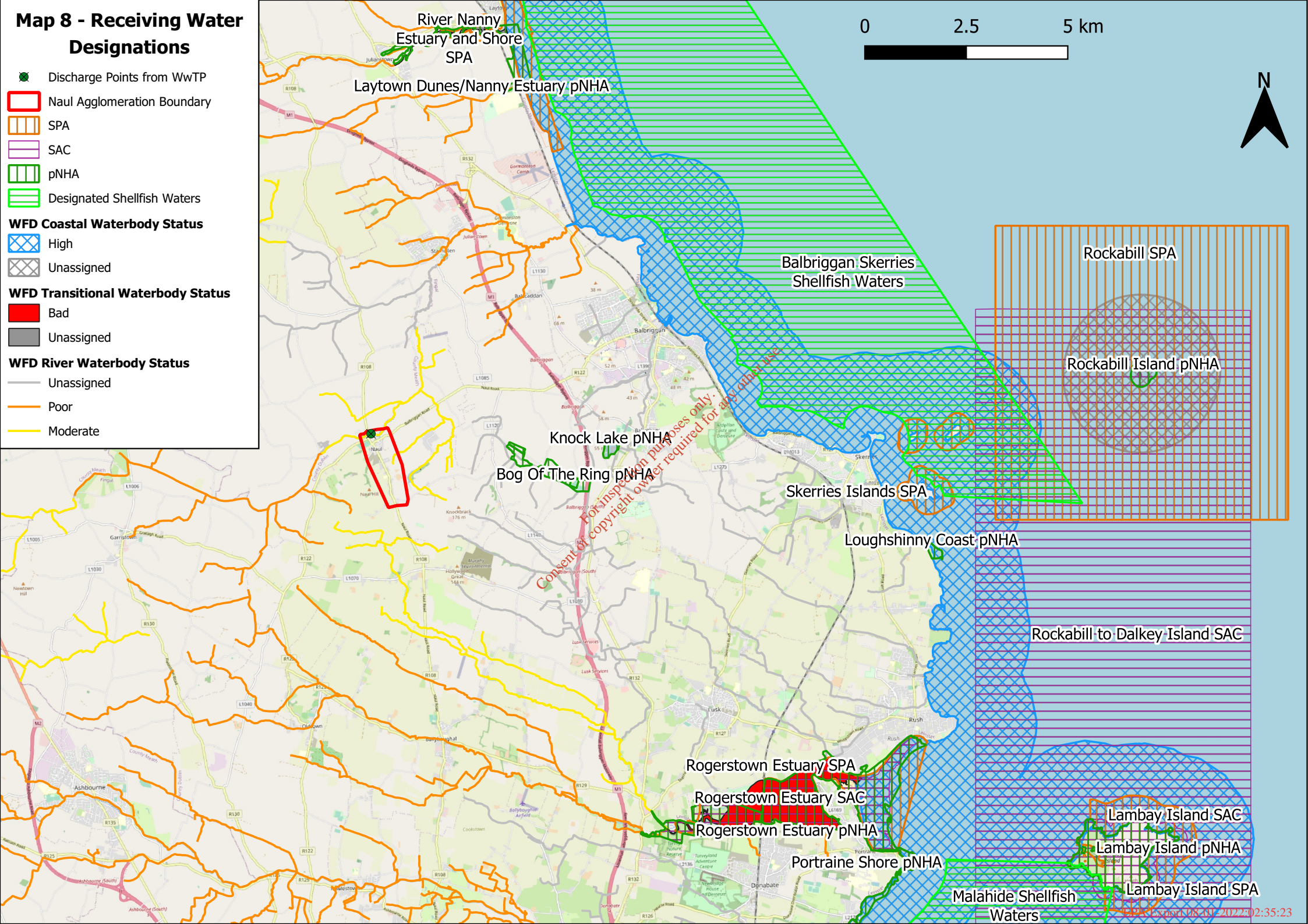
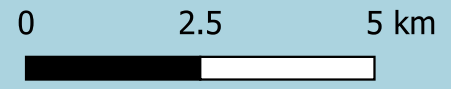

Attachment D.2.1: Impact Assessment Report

1. Introduction

This Report provides a summary of the Impact Assessments prepared to determine the impact of the discharges from the Naul agglomeration on the receiving waterbody, Delvin River (Delvin_020), and its associated downstream designations, and also addresses the criteria as outlined in **Section D.2** of the EPA guidance document.

2. Water Environment

Naul WwTP discharges to the Delvin River (Delvin_020). Delvin_020 is within the Nanny-Delvin Catchment (Hydrometric Area 08). This catchment includes the area drained by the by the Rivers Nanny and Delvin and by all streams entering tidal water between Mornington Point and Sea Mount, Co. Dublin, draining a total area of 711 km². This catchment is characterised by an undulating landscape, underlain for the most part by impure limestones and shales with metamorphic bedrock underlying the northern part of the catchment. There are no significant sand or gravel aquifers in the catchment.

The draft 3rd cycle Catchment Report (2021) for this hydrometric area, determined that for river waterbodies excess nutrients remain the most prevalent issue; along with morphology, organic pollution, sediment, hydrology and chemical pollution issues. Pressures identified affecting the greatest number of waterbodies within hydrometric area 08 include agriculture, followed by hydromorphology, urban wastewater, domestic waste water, urban run-off, industry and others. Naul WwTP is not listed as a significant pressure in At Risk waterbodies in the draft 3rd cycle catchment assessment. The Delvin_020 is included in the areas requiring agricultural measures – multiple measures (P/Sediment and N). The Delvin_020 is a 3rd cycle area for action and is classified as an area for Restoration.

The reason for assigning the Delvin as an area for action is reported as follows:

“Border catchment with Fingal, increasing MRP in recent years, high MRP in upper catchment, agri + MWWTPs suspected significant pressures. There are pressures in the lower catchment such as Stamullen WWTP and Section 4 discharges, however MRP is above EQS before Stamullen. Catchment investigations in 1st cycle by MMU. Catchment has probably received less attention from Meath CC as it's a border catchment so LAWPRO approach could be of benefit. If proposed area for action was to be reduced then focus on 2 uppermost waterbodies 010 and 020.”

The Delvin River has been classified by the EPA as having Moderate water quality under the WFD (2013 – 2018) and is further assessed as being At Risk of not achieving Good water quality status during 2022-2027. Significant pressures for the Delvin_020 have been determined, within the draft 3rd cycle Catchment Report, as Agriculture, Hydromorphology and Mines and Quarries.

The Delvin_020 waterbody trends (at the Br NW of Forty Acres station, downstream of the operational discharges) for Ortho-P for 2013-2018 are Upwards (increasing concentrations) while trends for Total Ammonia are downwards (decreasing concentrations), but both are not statistically significant. Ammonium is noted as High under WFD status. Ortho-P deteriorated in indicative quality from Poor to Bad from 2010-2015 to 2013-2018. However, Ortho-P is noted as Moderate under WFD status.

The EPA undertake biological monitoring of the Delvin River at various locations. Upstream of the WwTP at RS08D010080 (ca. 1.5 km upstream), the 2020 monitoring reported a Q value of 3 (Poor). Downstream of the WwTP at RS08D010250 (ca. 4 km downstream) the 2020 monitoring reported a Q value of 3-4 (Moderate).

Recent ambient monitoring data for Delvin_020 (2019-2021, catchments.ie) is shown in the tables below.

Table D.2.1- Ambient Monitoring – Upstream of the Primary Discharge Location at RS08D010080 (**Data Source:** Data from 2019-2021 (catchments.ie))

Parameter	pH	BOD (mg/l)	Ortho-P (mg/l)	Total Ammonia (mg/l)	DO (mg/l)	DO (%sat)	Temp (°C)
Number of Samples	13	13	13	13	13	13	13
Max result	8.3	4.3	0.17	0.094	8.3	105	16.7
Min result	7.6	0.5	0.019	0.01	7.6	71	2.9
Average result	7.96	0.99	0.0715	0.0391	7.96	93.5	9.9
Mean EQS		≤1.5**	≤0.035**	≤0.04*			
Overall compliance with relevant EQS (Mean)		Yes	No	Yes			

*Mean High status under S.I. No. 77/2018 – Ammonium is noted as High under 2013-2018 WFD status.

** Mean Good status under S.I. No. 77/2019

Table D.2.2 - Ambient Monitoring – Downstream of the Primary Discharge Location at RS08D010250 (**Data Source:** Data from 2019-2021 (catchments.ie))

Parameter	pH	BOD (mg/l)	Ortho-P (mg/l)	Total Ammonia (mg/l)	DO (mg/l)	DO(%sat)	Temp (°C)
Number of Samples	13	13	13	13	13	13	13
Max result	8.4	2	0.17	0.11	13.5	118	17
Min result	8	0.5	0.021	0.01	8.8	89	3.2
Average result	8.2	0.785	0.078	0.033	11.3	101	10.12

Parameter	pH	BOD (mg/l)	Ortho-P (mg/l)	Total Ammonia (mg/l)	DO (mg/l)	DO(%sat)	Temp (°C)
Mean EQS		≤1.5**	≤0.035**	≤0.04*			
Overall compliance with relevant EQS (Mean)		Yes	No	Yes			

*Mean High status under S.I. No. 77/2019 – Ammonium is noted as High under 2013-2018 WFD status.

** Mean Good status under S.I. No. 77/2019

Based on ambient monitoring results upstream and downstream of the current discharge for the period between January 2019 to Sept 2021, the mean concentration for BOD and Ammonia are within the required EQSs for Good and High status, respectively.

In relation to Ortho-P, the mean upstream and downstream concentration was 0.0715 mg/l and 0.078mg/l, respectively (mean Good Status EQS - 0.035mg/l), indicating that the EQS for Good status is not met upstream or downstream of the WwTP. As noted above, the significant pressures for the Delvin_020 have been determined, within the draft 3rd cycle Catchment Report, as Agriculture, Hydromorphology and Mines and Quarries. Naul WwTP is not listed as a significant pressure.

3. Waste Assimilative Capacity Calculations

Waste Assimilative Capacity (WAC) calculations have been completed to inform this WWDL application process and to show the impact of the primary discharge from the upgraded WwTP on the receiving waterbody, the Delvin River (Delvin_020).

The calculations were based on the 95%ile flow in the river, 0.06m³/s, (as confirmed by the EPA on the 8th December 2021), the projected normal waste water loading of 167.6 m³/d and the proposed operational standards/ELVs. The calculations use both the actual background concentrations (Station - RS08D010080, data from 2019-2021) and the EPA's "notionally clean river" concentrations.

For both BOD and Ortho-P, the Good status EQS under S.I No. 77 of 2019 was used and for Ammonia the High status EQS was used based on the current High status of this parameter under the 2013-2018 WFD cycle.

Based on the actual background concentrations, the WAC calculations showed that there would be sufficient assimilative capacity in the receiving water to receive the flows and loads associated with the upgraded WwTP for BOD and Ammonia based on ELVs of 25mg/l and 1.6mg/l, respectively. The Good status EQS for BOD, and High status EQS for Ammonia, would be met downstream. However, due to the upper catchment issues in terms of Ortho-P, there would not be sufficient assimilative capacity in receiving water in terms of this parameter based on an ELV of 1mg/l. However, for a notionally clean river there would be more than sufficient assimilative capacity in the receiving water for Ortho-P to meet the Good status EQS.

Catchment measures, which are not in the control or remit of IW, are required to be implemented to reduce the high background concentrations of Ortho-P in the catchment.

The upgrade of the Naul WwTP and the achievement of the ELVs proposed (*i.e.*, BOD 25mg/l, Ammonia 1.6mg/l and Ortho-P 1mg/l) will assist the waterbody in achieving Good status in line with the WFD requirements by 2027 and will contribute to maintaining the current High status of Ammonium.

Table D.2.3 - WAC for 745 PE (based on Notionally Clean River)

Parameter	Upstream River Conc ^{Note 1}	Proposed ELV	Contribution from Primary Discharge (mg/l)	Predicted D/S Conc (mg/l)	Relevant Standard (mg/l)
BOD	0.26	25	0.783	1.04	<2.6 ^{Note 2}
Ortho-Phosphate (MRP)	0.005	1	0.031	0.036	<0.075 ^{Note 2}
Total Ammonia	0.008	1.6	0.050	0.058	<0.09 ^{Note 3}

Note 1: Based on notionally clean river approach.

Note 2: European Union Environmental Objectives (Surface Waters) (Amendment). Regulations 2019 (S.I. No. 77 of 2019) – Good Status EQS.

Note 3: European Union Environmental Objectives (Surface Waters) (Amendment). Regulations 2019 (S.I. No. 77 of 2019) – High Status EQS to take account of the current High status of Ammonium.

Table D.2.4 - WAC for 745 PE (Based on background data (2019 - 2021) from Station RS08D010080)

Parameter	Upstream River Conc ^{Note 1}	Proposed ELV	Contribution from Primary Discharge (mg/l)	Predicted D/S Conc (mg/l)	Relevant Standard (mg/l) (Good Status)
BOD	0.992	25	0.783	1.775	<2.6 ^{Note 2}
Ortho-Phosphate (MRP)	0.0715	1	0.031	0.103	<0.075 ^{Note 2}
Total Ammonia	0.0391	1.6	0.050	0.089	<0.09 ^{Note 3}

Note 1: Based on notionally clean river approach.

Note 2: European Union Environmental Objectives (Surface Waters) (Amendment). Regulations 2019 (S.I. No. 77 of 2019) – Good Status EQS

Note 3: European Union Environmental Objectives (Surface Waters) (Amendment). Regulations 2019 (S.I. No. 77 of 2019) – High Status EQS to take account of the current High status of Ammonium.

Refer to **Attachment D.2.3** for the WAC calculations.

4. Appropriate Assessment Screening

An Appropriate Assessment (AA) screening of the proposed operational discharges from the upgraded Naul WwTP in Naul, County Dublin was prepared to inform this WWDL application process (see **Attachment D.2.2**). It assessed whether the discharge activity, alone or in combination with other plans and projects, are likely to have significant effects on a European Site(s) in view of best scientific knowledge and the conservation objectives of the site(s).

The European sites within the wider study area of the Naul WwTW include River Nanny Estuary and Shore SPA, Rogerstown Estuary SAC, Rogerstown Estuary SPA, Skerries Islands SPA, Boyne Coast and Estuary SAC, Malahide Estuary SAC, Boyne Estuary SPA, River Boyne and River Blackwater SAC, Malahide Estuary SPA and Rockabill to Dalkey

Island SAC. After a preliminary screening exercise, it was concluded that all the above sites apart from the River Nanny Estuary and Shore SPA could be excluded from further assessment due to the lack of a direct or indirect pathway for likely significant effects. Therefore, the remainder of the screening assessment only considered the River Nanny Estuary and Shore SPA, as a possible pathway, albeit tenuous, for likely significant effects on this site was identified.

The screening assessment concluded that that the proposed operational discharges are not likely to have significant effects on the River Nanny Estuary and Shore SPA, or indeed any European sites, having regard to their conservation objectives, for the following reasons:

- The Naul agglomeration is a small catchment area currently serving 674 p.e. (2020 peak week loading) with a maximum p.e. of 745 under this licence review.
- The nearest downstream European site is the River Nanny Estuary and Shore SPA which has a remote indirect connectivity *via ca.* >10 km of the Delvin River and on through *ca.* 2 km of the Irish Sea.
- The operational standards proposed by IW have been set so as to ensure that the discharges from the agglomeration contribute towards achieving at least Good status in accordance with the European Union Environmental Objectives (Surface Waters) (Amendment) Regulations 2019 (S.I. No. 77 of 2019) and in maintaining the current High WFD status of Ammonium in the Delvin_020.

Based on the above it has been concluded following screening that the operational discharges from the Naul agglomeration are not directly connected with or necessary to the management of any European Site and it is considered, for the reasons set out above, that it can be excluded, on the basis of objective information, that the operational discharges, individually or in combination with other plans or projects, will have a significant effect on any European Site and accordingly determined that an Appropriate Assessment is not required.

5. Priority Substance Assessment

An assessment of the potential for impacts on receiving waters from priority substances in the primary discharge has been carried out to inform this WWDL application. Estimated data from the PRTR reporting tool was used to inform this desktop assessment. The assessment considered the primary discharge relevant to Environmental Quality Standards (EQS) for priority substances in surface waters, as set out in the Surface Waters Regulations (S.I No. 77 of 2019) . It was concluded that none of the substances listed in the Specific Pollutants, Priority and Priority Hazardous Substances, are likely to be present in the effluent discharge to the Delvin River, at concentrations above the standards in S.I No. 77 of 2019.

This Report is contained in **Attachment D.2.4**: Priority Substance Assessment.

6. Designated Shellfish Water/Area

The Balbriggan/Skerries designated shellfish water/area is *ca.* 10 km downstream of the Naul discharge location. The Sea Fisheries Protection Authority (July 2021) have assigned this classified shellfish area as Class A, the highest quality standard. Shellfish from A

Classification areas can be taken for direct human consumption without further processing. The Marine Institute average dissolved concentrations for metals in shellfish waters for the period 2016-2019 and the microbial quality in shellfish flesh for 2018 were assessed within the draft 3rd cycle Catchment Report for the Hydrometric Area 08. This assessment determined the WFD protected area objective for shellfish areas are met.

Based on the above, it can be concluded that the current operational discharges from the Naul WwTP are not having an impact on the Balbriggan/Skerries designated shellfish area. As the proposed WwTP interim upgrade will lead to an improvement in effluent quality, the same conclusion can be applied.

7. River Flow Estimation

The 95th percentile flow for the Naul WwTP receiving waterbody, Delvin_020, was sourced from the EPA HydroNet Station 08002 (Naul (Delvin)) (E:313183, N:261157). The 95th percentile flow at this location is reported, and has been confirmed by the EPA on the 8th December 2021, as 0.06 m³/s.

8. Combined Approach

The Waste Water Discharge Authorisation under the European Union (Waste Water Discharge) Regulations 2007 to 2020, specify that a '*combined approach*' in relation to licensing of waste water works must be taken, whereby the emission limits for the discharge are established on the basis of the stricter of either or both, the limits and controls required under the Urban Waste Water Treatment Regulations, 2001, as amended, and the limits determined under statute or Directive for the purpose of achieving the environmental objectives established for surface waters, groundwater or protected areas for the water body into which the discharge is made.

The proposed ELVs give effect to the principle of the Combined Approach as defined in Waste Water Discharge (Authorisation) Regulations, 2007 to 2020 in that they accommodate the Urban Waste Water Regulations and the relevant designations /status of the receiving waterbody, the Delvin River.

9. Compliance with Relevant National or EU Legislation

As per **Attachment B.6**, the Naul WwTP has been designed to ensure that the emissions from the agglomeration will comply with, and will not result in the contravention of EU Legislation and National Regulations.

Once operational, the upgraded WwTP is expected to have a positive impact in terms of reduction in the levels of nutrients being discharged into the Delvin River. The discharge will not compromise the achievement of the objectives and EQSs established for any European sites water dependant species and natural habitats and designations in the wider environs or downstream of the agglomeration.

10. Data Sources

The following key data sources were used to complete this application.

- Online data available on held by the NPWS, EPA, and Irish Water:
 - www.npws.ie

- epawebapp.epa.ie
- gis.epa.ie/EPAMaps
- <https://gis.daera-ni.gov.uk/arcgis/apps/webappviewer/>
- catchments.ie
- GIS data for European site boundaries obtained in digital format online from European Environmental Agency
- Irish Water/Fingal County Council sampling and monitoring data.

11. Cumulative and In Combination Effects

The Appropriate Assessment Screening Report addresses in combination effects. Refer to **Attachments D.2.2.**

12. Mixing zone or transitional areas of exceedance

Based on the 95%ile river flow (0.060 m³/s) and the Naul WwTP DWF (167.6 m³/d), there are ca. 31 dilutions estimated immediately in the proximity of the primary discharge point.

13. Dilutions and retention times for lakes

Not applicable. No discharges to lakes.

14. The impact of the discharges on any environmental media other than those into which the emissions are to be made

Not applicable. No other relevant media into which the emissions are to be made.

15. Groundwater Details

Not applicable. No discharge to ground waters.

16. High Status Waterbodies

Not applicable. No High status waterbodies within the region of the Naul WwTP and/or the operational discharges.

17. Fresh Water Pearl Mussels

Not applicable. No Fresh Water Pearl Mussels within the region of the Naul WwTP and/or the Primary Discharge point.

18. For waste water treatment plants with coastal discharges, provide evidence that the end of the discharge pipe is below the mean spring tide low water line

Not applicable. Discharge is not to coastal water.

Waste Assimilative Capacity (WAC) Calculation

Calculation Sheet

Date	17/12/2012
------	------------

WWTP	Naul WwTP
Name of River	Delvin River (Delvin_020)

		Data Source	m ³ /d
95% ile Flow	0.060	EPA HydroNet - Station 08002 (NAUL (DELVIN))	5,184

Proposed Operational Standards/ELVs	mg/l
Carbonaceous BOD	25.000
Ammonia	1.600
Ortho-Phosphate (OP)	1.000

Note: Current WFD Status 2013-18: Moderate

Average Background Concentration (Notional)			Average Background Concentration (Actual)				
Parameter	mg/l	Data Source	mg/l	Data Source			
Carbonaceous BOD	0.260	EPA Notionally Clean	0.992	Station - RS08D010080	Data from 2019-2021		
Ammonia	0.008	EPA Notionally Clean	0.0391	Station - RS08D010080			
Ortho-Phosphate (OP)	0.005	EPA Notionally Clean	0.0715	Station - RS08D010080			
Allowable Downstream Concentration (Surface Water Regulations)							
Parameter	95% ile mg/l	Data Ref					
Carbonaceous BOD	2.60	Surface Water Regs (S.I. No. 77 of 2019) Good Status EQS's for BOD & Ortho-P & High Status for Ammonia					
Ammonia	0.09						
Ortho-Phosphate (OP)	0.075						
PE	WWTP Daily Flow (DWF)	Allowable effluent conc (Notionally Clean)			Allowable effluent conc (Actual)		
		BOD	NH	OP	BOD	NH	OP
	m ³ /d	mg/l	mg/l	mg/l	mg/l	mg/l	mg/l
745	167.6	74.97	2.63	2.24	52.32	177.18	4,993.92
PE	WWTP Daily Flow (DWF)	WAC (Notionally Clean)			WAC (Actual)		
		BOD	NH	OP	BOD	NH	OP
	m ³ /d	kg/d	kg/d	kg/d	kg/d	kg/d	kg/d
745	167.6	12.57	0.44	0.38	8.77	29.70	837.11
PE	WWTP Daily Flow (DWF)	Resultant Concentration (Notionally Clean)			Resultant Concentration (Actual)		
		BOD	NH	OP	BOD	NH	OP
	m ³ /d	mg/l	mg/l	mg/l	mg/l	mg/l	mg/l
745	167.6	1.04	0.058	0.036	1.775	0.089	0.103
		Acceptable	Acceptable	Acceptable	Acceptable	Acceptable	Too High

Priority Substances Assessment

Agglomeration Name:	Naul Agglomeration
---------------------	--------------------

*For inspection purposes only.
Consent of copyright owner required for any other use.*



Table of Contents

1	Introduction	3
2	Desktop Study	3
2.1	Assessment of Analysis Required	3
2.2	Review Outcome of Desktop Study	4
3	Assessment of Significance and Recommendations	5
4	Conclusion	5

Appendix 1 – Screening of Parameters for Priority Substances

*For inspection purposes only.
Consent of copyright owner required for any other use.*

1 Introduction

This report has been prepared for the Naul agglomeration, to inform the application of a wastewater discharge licence.

The Naul agglomeration is centred on the village of Naul. The current WwTP at NGR 313239E, 261134N is designed for a population equivalent (p.e.) of 650 and is currently collecting loads of *ca.* 674 p.e. The WwTP provides secondary treatment *via* a conventional activated sludge plant with treated wastewater discharging to the Delvin River at NGR 313239E, 261155N. The current WwTP is considered to be inefficient, primarily due to dilute influent and a deficient activated sludge system.

The proposed upgraded WwTP will optimise the existing treatment process and also cater for additional capacity up to 745 p.e. The improvements to the WwTP will ensure a higher standard of treatment, with N and P removal, thereby reducing the concentration and frequency of the sludge washout effluent.

The source of waste water in the Naul agglomeration is predominantly domestic. This desk top study has been undertaken to determine the necessity, if any, for further analysis of the primary discharge based on the *Guidance on the Screening for Priority Substances for Waste Water Discharge Licences*, issued by the EPA. Relevant inputs to the Naul WwTP and estimates for the emissions from the discharge point have been taken into account in the preparation of this report.

2 Desktop Study

2.1 Assessment of Analysis Required

A. Review of all industrial inputs into WwTP

A review of available online mapping and all EPA licensed facilities was undertaken to determine the non-domestic discharge types which will be received at the Naul WwTP. In addition, all planning applications within the agglomeration, since 2017, were reviewed to determine the associated non-domestic discharges being sent to the Naul WwTP. The IW Technical Assessment Manual Sectoral Profile Data was reviewed to determine the potentially dangerous substances which could be released to sewer from industrial inputs.

As per the EPA, IPC and IE database, there are currently no industrial premises with an IPC licence within the agglomeration.

There are no trade effluent licences under Section 16 of the Water Pollution Act 1977 (amended 1990) within the agglomeration.

It is considered that the Priority Substances which are possibly being emitted to sewer have been well represented in this partial characterisation of the wastewater (**Table 2.1**).

Upon review of the types of businesses, amenities, and educational facilities in Naul, **Table 2.1** provides an indicative list of non-domestic discharge types to the WwTP and details potential dangerous/priority substance.

Table 2.1 – List of Non-Domestic Discharge Types to WwTP and Details of Potential Dangerous/Priority Substance

Type of Industry within the Agglomeration	Potential Source of Dangerous / Priority Substances (Yes / No)	Dangerous / Priority Substances Monitoring Undertaken (Yes / No)	List of Potential Dangerous Substances Based on Industry Type (Source: <i>Technical Assessment Manual - Sectoral Profile Data</i>)
Schools	Yes	Unknown	Dichloromethene Lead and its compounds Nickel and its compounds Tricholormethane
Construction	Yes	Unknown	Lead and its compounds Nickel and its compounds Mercury and its compounds Arsenic Chromium (III) Copper Zinc
Other supporting transport activities	Yes	Unknown	Benzene

B. Discharge monitoring

No primary discharge monitoring for the possible presence of Specific Pollutants, Priority and Priority Hazardous Substances as outlined in Table 10, 11 and 12 of European Communities Environmental Objectives (Surface Waters) Regulations 2009, as amended is available for this agglomeration.

C. Downstream monitoring location's participation in relevant monitoring programme

There is recent no priority substances monitoring data for the downstream ambient monitoring location, Delvin River.

D. Participation in PRTR reporting

Estimated data from the PRTR reporting tool was required for this desktop assessment as measured data was unavailable for all parameters in Appendix 1.

2.2 Review Outcome of Desktop Study

Following the desktop study, all parameters in Appendix 1 have been assessed to establish any potential impact on the receiving waters. Priority substance measured concentrations in the primary discharge were not available for any parameters, as such estimated concentrations were assessed. This desktop study is considered to provide partial characterisation of the wastewater.

3 Assessment of Significance and Recommendations

An assessment of the potential for impacts on receiving waters from priority substances in the primary discharge has been carried out. The assessment considers the primary discharge relevant to Environmental Quality Standards (EQS) for priority substances in surface waters, as set out in the European Communities Environmental Objectives (Surface Waters) Regulations 2009, as amended.

Based on the estimated data, no parameters were identified as potentially being higher than the required EQS.

Does the assessment use the Desk Top Study Method or Screening Analysis to determine if the discharge contains the parameters in Appendix 1 of the EPA guidance	Desk Top Study
Does the assessment include a review of licensed / authorised inputs to the works?	Yes
Does the assessment include a review of other (unauthorised) inputs to the works?	Yes
Does the report include an assessment of the significance of the results where a listed material is present in the discharge? (e.g., impact on the relevant EQS standard for the receiving water)	Yes
Does the assessment identify that priority substances may be impacting the receiving water?	No
Does the Improvement Programme for the agglomeration include the elimination / reduction of all priority substances identified as having an impact on receiving water quality?	N/A

4 Conclusion

An assessment of the potential for impacts on receiving waters from priority substances in the primary discharge has been carried out to inform this WWDL application. Estimated data from the PRTR reporting tool was used to inform this desktop assessment. The assessment considered the primary discharge relevant to Environmental Quality Standards (EQS) for priority substances in surface waters, as set out in the Surface Waters Regulations (S.I No. 77 of 2019) . It can be concluded that none of the substances listed in the Specific Pollutants, Priority and Priority Hazardous Substances, are likely to be present in the effluent discharge to the Delvin River, at concentrations above the standards in S.I No. 77 of 2019.

Based on the results of this desk top study, it can be determined that **no for further analysis** of the discharge, based on the *Guidance on the Screening for Priority Substances for Waste Water Discharge Licences*, issued by the EPA, is required.

Appendix 1 – Screening of Parameters for Priority Substances

AA: Annual Average

MAC: Maximum Allowable Concentration

EQS: Environmental Quality Standards

Dilution factor in receiving water: 31 dilutions estimated immediately in the proximity of the discharge point (based on a DWF of 167.6m³/day and 95%ile flow 0.06 m³/s) the nature of the receiving waterbody, Delvin River)

No.	Compound	Group of compounds	AA-EQS Inland SW (µg/l)	AA-EQS Other SW (µg/l)	Estimated Conc. (µg/l) ¹	Data Source	Sample Date (if applicable)	Effluent Concentration above AA concentration (Yes/No)	Effluent Concentration above AA concentration after dilution (Yes/No)
1	Benzene	VOCs	10	8	0.000	PRTR Electronic Toolset	N/A	No	No
2	Carbon tetrachloride	VOCs	12	12	0.000	PRTR Electronic Toolset	N/A	No	No
3	1,2-Dichloroethane	VOCs	10	10	0.000	PRTR Electronic Toolset	N/A	No	No
4	Dichloromethane	VOCs	20	20	0.000	PRTR Electronic Toolset	N/A	No	No
5	Tetrachloroethylene	VOCs	10	10	0.000	PRTR Electronic Toolset	N/A	No	No
6	Trichloroethylene	VOCs	10	10	0.000	PRTR Electronic Toolset	N/A	No	No
7	Trichlorobenzenes	VOCs	0.4	0.4	0.000	PRTR Electronic Toolset	N/A	No	No
8	Trichloromethane	VOCs	2.5	2.5	0.000	PRTR Electronic Toolset	N/A	No	No
9	Xylenes (all isomers)	VOCs	10	10	0.000	PRTR Electronic Toolset	N/A	No	No

No.	Compound	Group of compounds	AA-EQS Inland SW (µg/l)	AA-EQS Other SW (µg/l)	Estimated Conc. (µg/l) ¹	Data Source	Sample Date (if applicable)	Effluent Concentration above AA concentration (Yes/No)	Effluent Concentration above AA concentration after dilution (Yes/No)
10	Ethyl Benzene	VOCs	n/a	n/a	0.000	PRTR Electronic Toolset	N/A	N/A	N/A
11	Toluene	VOCs	10	10	0.000	PRTR Electronic Toolset	N/A	No	No
12	Naphthlene ¹	PAHs	2	2	0.000	PRTR Electronic Toolset	N/A	No	No
13	Fluoranthene ¹	PAHs	0.0063	0.0063	0.000	PRTR Electronic Toolset	N/A	No	No
14	Benzo[k]fluoranthene ²	PAHs	MAC of 0.017	MAC of 0.017	0.000	PRTR Electronic Toolset	N/A	No	No
15	Benzo[ghi]perylene ²	PAHs	MAC of 8.2×10^{-3}	MAC of 8.2×10^{-4}	0.000	PRTR Electronic Toolset	N/A	No	No
16	Indeno[1,2,3-c,d]pyrene ²	PAHs			0.000	PRTR Electronic Toolset	N/A	No	No
17	Benzo[b]fluoranthene ²	PAHs	MAC of 0.017	MAC of 0.017	0.000	PRTR Electronic Toolset	N/A	No	No
18	Benzo[a]pyrene	PAHs	1.7×10^{-4}	1.7×10^{-4}	0.000	PRTR Electronic Toolset	N/A	No	No
19	Di(2-ethylhexyl)phthalate (DEHP)	Plasticiser	1.3	1.3	0.000	PRTR Electronic Toolset	N/A	No	No
20	Isodrin ³	Pesticides	$\Sigma=0.01$	$\Sigma=0.005$	0.000	PRTR Electronic Toolset	N/A	No	No

¹ The EQS for these substances shall take effect from 22 December 2015

² No indicative parameter is provided for this group of substances

³ Σ of Aldrin, Dieldrin, Endrin and Isodrin.

No.	Compound	Group of compounds	AA-EQS Inland SW (µg/l)	AA-EQS Other SW (µg/l)	Estimated Conc. (µg/l) ¹	Data Source	Sample Date (if applicable)	Effluent Concentration above AA concentration (Yes/No)	Effluent Concentration above AA concentration after dilution (Yes/No)
21	Dieldrin ³	Pesticides			0.000	PRTR Electronic Toolset	N/A	No	No
22	Diuron	Pesticides	0.2	0.2	0.000	PRTR Electronic Toolset	N/A	No	No
23	Isoproturon	Pesticides	0.3	0.3	0.000	PRTR Electronic Toolset	N/A	No	No
24	Atrazine	Pesticides	0.6	0.6	0.000	PRTR Electronic Toolset	N/A	No	No
25	Simazine	Pesticides	1	1	0.000	PRTR Electronic Toolset	N/A	No	No
26	Glyphosate	Pesticides	60	-	0.000	PRTR Electronic Toolset	N/A	No	No
27	Mecoprop	Pesticides	n/a	n/a	0.000	PRTR Electronic Toolset	N/A	N/A	N/A
28	2,4-D	Pesticides	n/a	n/a	0.000	PRTR Electronic Toolset	N/A	N/A	N/A
29	MCPA	Pesticides	n/a	n/a	0.000	PRTR Electronic Toolset	N/A	N/A	N/A
30	Linuron	Pesticides	0.7	0.7	0.000	PRTR Electronic Toolset	N/A	No	No
31	Dichlobenil	Pesticides	n/a	n/a	0.000	PRTR Electronic Toolset	N/A	N/A	N/A
32	2,6-Dichlorobenzamide	Pesticides	n/a	n/a	0.000	PRTR Electronic Toolset	N/A	N/A	N/A
33	PCBs	PCBs	n/a	n/a	0.000	PRTR Electronic Toolset	N/A	N/A	N/A

No.	Compound	Group of compounds	AA-EQS Inland SW (µg/l)	AA-EQS Other SW (µg/l)	Estimated Conc. (µg/l) ¹	Data Source	Sample Date (if applicable)	Effluent Concentration above AA concentration (Yes/No)	Effluent Concentration above AA concentration after dilution (Yes/No)
34	Phenols (as Total C)	Phenols	8	8	0.0001	PRTR Electronic Toolset	N/A	No	No
35	Lead	Metals	1.2	1.3	0.000	PRTR Electronic Toolset	N/A	No	No
36	Arsenic	Metals	25	20	0.000	PRTR Electronic Toolset	N/A	No	No
37	Copper	Metals	5 or 30 ²	5	0.000	PRTR Electronic Toolset	N/A	No	No
38	Zinc	Metals	8 or 50 or 100 ³	40	0.0001	PRTR Electronic Toolset	N/A	No	No
39	Cadmium	Metals	0.08 or 0.09 or 0.15 or 0.25 ⁴	0.2	0.000	PRTR Electronic Toolset	N/A	No	No
40	Mercury	Metals	MAC of 0.07	MAC of 0.07	0.000	PRTR Electronic Toolset	N/A	No	No
41	Chromium VI	Metals	3.4	0.6	0.000	PRTR Electronic Toolset	N/A	No	No
42	Selenium	Metals	n/a	n/a	0.000	PRTR Electronic Toolset	N/A	N/A	N/A
43	Antimony	Metals	n/a	n/a	0.000	PRTR Electronic Toolset	N/A	N/A	N/A
44	Molybdenum	Metals	n/a	n/a	0.000	PRTR Electronic Toolset	N/A	N/A	N/A
45	Tin	Metals	n/a	n/a	0.000	PRTR Electronic Toolset	N/A	N/A	N/A

No.	Compound	Group of compounds	AA-EQS Inland SW (µg/l)	AA-EQS Other SW (µg/l)	Estimated Conc. (µg/l) ¹	Data Source	Sample Date (if applicable)	Effluent Concentration above AA concentration (Yes/No)	Effluent Concentration above AA concentration after dilution (Yes/No)
46	Barium	Metals	n/a	n/a	0.000	PRTR Electronic Toolset	N/A	N/A	N/A
47	Boron	Metals	n/a	n/a	0.0001	PRTR Electronic Toolset	N/A	N/A	N/A
48	Cobalt	Metals	n/a	n/a	0.000	PRTR Electronic Toolset	N/A	N/A	N/A
49	Vanadium	Metals	n/a	n/a	0.000	PRTR Electronic Toolset	N/A	N/A	N/A
50	Nickel	Metals	4	8.6	0.000	PRTR Electronic Toolset	N/A	No	No
51	Fluoride	General	500	1,500	0.001	PRTR Electronic Toolset	N/A	No	No
52	Chloride	General	n/a	n/a	0.065	PRTR Electronic Toolset	N/A	N/A	N/A
53	TOC	General	n/a	n/a	0.013	PRTR Electronic Toolset	N/A	N/A	N/A
54	Cyanide	General	10	10	0.000	PRTR Electronic Toolset	N/A	No	No
	Conductivity	General	n/a	n/a	-	PRTR Electronic Toolset	N/A	N/A	N/A
	Hardness (mg/l CaCO ₃)	General	n/a	n/a	0.291	PRTR Electronic Toolset	N/A	N/A	N/A
	pH	General	n/a	n/a	-	PRTR Electronic Toolset	N/A	N/A	N/A

Notes:

1. Where measured values are available these should be used instead of estimated values from PRTR tool.
2. In the case of Copper, the value 5 applies where the water hardness measured in mg/l CaCO₃ is less than or equal to 100; the value 30 applies where the water hardness exceeds 100 mg/l CaCO₃. Estimated CaCO₃ value > 100 where no sampling data available (based on PRTR tool)
3. In the case of Zinc, the standard shall be 8 µg/l for water hardness with annual average values less than or equal to 10 mg/l CaCO₃, 50 µg/l for water hardness greater than 10 mg/l CaCO₃ and less than or equal to 100 mg/l CaCO₃ and 100 µg/l elsewhere. Estimated CaCO₃ value > 100 where no sampling data available
4. For Cadmium and its compounds the EQS values vary dependent upon the hardness of the water as specified in five class categories (Class 1: <40 mg CaCO₃/l, Class 2: 40 to <50 mg CaCO₃/l, Class 3: 50 to <100 mg CaCO₃/l, Class 4: 100 to <200 mg CaCO₃/l and Class 5: >200 mg CaCO₃/l)

*For inspection purposes only.
Consent of copyright owner required for any other use.*



SECTION E: DECLARATION

*For inspection purposes only.
Consent of copyright owner required for any other use.*



Waste Water Discharge Authorisation

Attachment E.1 – Signed Declaration

Applicant Name:*

Naul

Application I.D.:*

TBC – New WWDA application

*For inspection purposes only.
Consent of copyright owner required for any other use.*

SECTION E: DECLARATION

Complete the declaration below and submit a scanned copy of the signed declaration.

Declaration:

I hereby make application for a licence / revised licence, pursuant to the provisions of the pursuant to the provisions of the European Union (Waste Water Discharge) Regulations 2007 to 2020.

- I declare that all the information and particulars given in this application form and all associated attachments are truthful, accurate and complete.
- I give consent to the EPA to copy this application form and all associated attachments for its own use and to make it available for inspection and copying by the public both in paper form and on the EPA's website. This consent relates to the application form itself, all associated attachments and to any further information or submission, whether provided by me as the Applicant or any person acting on the Applicant's behalf.

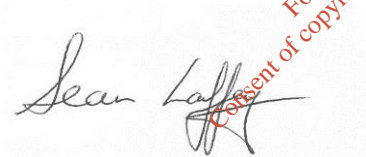

For inspection purposes only.
Consent of copyright owner required for any other use.

Signed by: * _____ **Date:** * 21stDecember 2021
(on behalf of the organisation)

Print signature name: * Sean Laffey

Position in organisation: * Head of Asset Management