

Site Layout  
Not to Scale

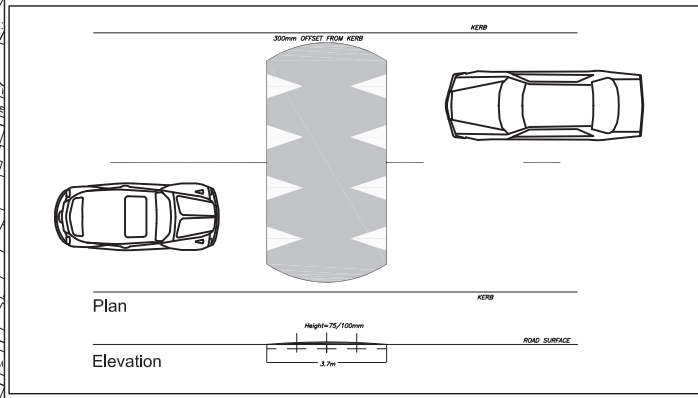

Seabury Road, Malahide, Co. Dublin.

Site Location Map  
Not to Scale



Traffic Calming Ramp  
Not to Scale

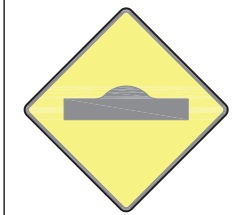

Road Signage  
Not to Scale

COMHARLE CONTAIE FHINE GALL  
FINGAL COUNTY COUNCIL  
ROAD TRAFFIC ACTS 1993 – 2015  
PUBLIC TRANSPORT REGULATION ACT, 2009  
TRAFFIC CALMING SCHEME  
Seabury Road, Malahide

Fingal County Council in exercise of the powers conferred on it under Section 38 of the Road Traffic Act, 1994 and Section 46 of the Public Transport Regulation Act, 2009 hereby gives notice that it has prepared a Scheme for the provision of traffic calming measures at the following location:

- Seabury Road, Malahide

The scheme provides for traffic calming ramps, appropriate road signage and markings where necessary.

Plans and particulars of the Scheme as shown on Drawing Number 2018-PD-TC-010, are available for inspection from Thursday 28<sup>th</sup> June to Thursday 16<sup>th</sup> August 2018 as follows:-

Location	Day	Opening Hours
Fingal County Council, County Hall, Main Street, Swords, Co. Dublin.	Monday – Friday	9:00am – 5:30 pm (4.30 p.m. Friday)
Malahide Library, The Mall, Malahide, Co. Dublin.	Opening Hours	Mon- Thurs: 9:45am – 8:00pm Fri and Sat: 9:45am – 1:00pm and 1:45pm – 5:00pm Bank holiday weekends: Closed Saturday and Monday Sunday: Closed
Fortmarnock Sports & Leisure Club, Blackwood Lane, Fortmarnock, Co. Dublin.	Opening Hours	Centre Opening Hours

The proposed Scheme is also available to view on Fingal County Council's website: <https://consult.fingal.ie/>

Representations in relation to the proposed Scheme may be made in writing to the Road Authority, as follows: Administrative Officer, Howth Malahide Operations, Fingal County Council, Grove Road, Blanchardstown, Dublin 15 or email [howmaloparea@fingal.ie](mailto:howmaloparea@fingal.ie) to be received no later than 4.30 pm on Thursday 13th August 2018.

Administrative Officer  
Howth Malahide Operations

Dated: Thursday 28<sup>th</sup> June 2018.

All comments, including the names of those making comments, submitted to the Council in regard to this Traffic Calming Scheme will form part of the statutory report to be presented to the monthly meeting of Fingal County Council.

Accordingly the statutory report will list the persons or bodies who made submissions or observations with respect to the proposed Traffic Calming Scheme in accordance with the regulations of the Road Traffic Act 1994.

The submissions will also be included in the minutes of that meeting and consequently will appear on the Council's Website. By making a submission the name of individual or bodies will appear on the statutory report and minutes of the meeting.

© Ordnance Survey Ireland. All Rights Reserved. Licence number 2017/24/CCMAIFingalCountyCouncil

Fingal County Council  
Operations Department  
Traffic Section  
Traffic Management  
Scheme 2018

PUBLIC DISPLAY  
PROPOSED TRAFFIC CALMING SCHEME  
- SEABURY ROAD, MALAHIDE, CO. DUBLIN.

Comhairle Contae Fhine Gall Fingal County Council		Roinn na nOibríochtaí Operations Department	
Traffic Section - Civic Offices, Grove Road, Blanchardstown, Dublin 15 ☎ (01) 8905000 📧 roads@fingal.ie			
Director of Services: David Storey	Date:		
Senior Engineer: Karen A Gallagher	Scale: NTS		
Senior Exec. Engineer: Andrew Nolan	Drawn by: cof		
Project Engineer: Silvana Di Ciccio	Revision:		
Drawing Number:	2018-PD-TC-010		

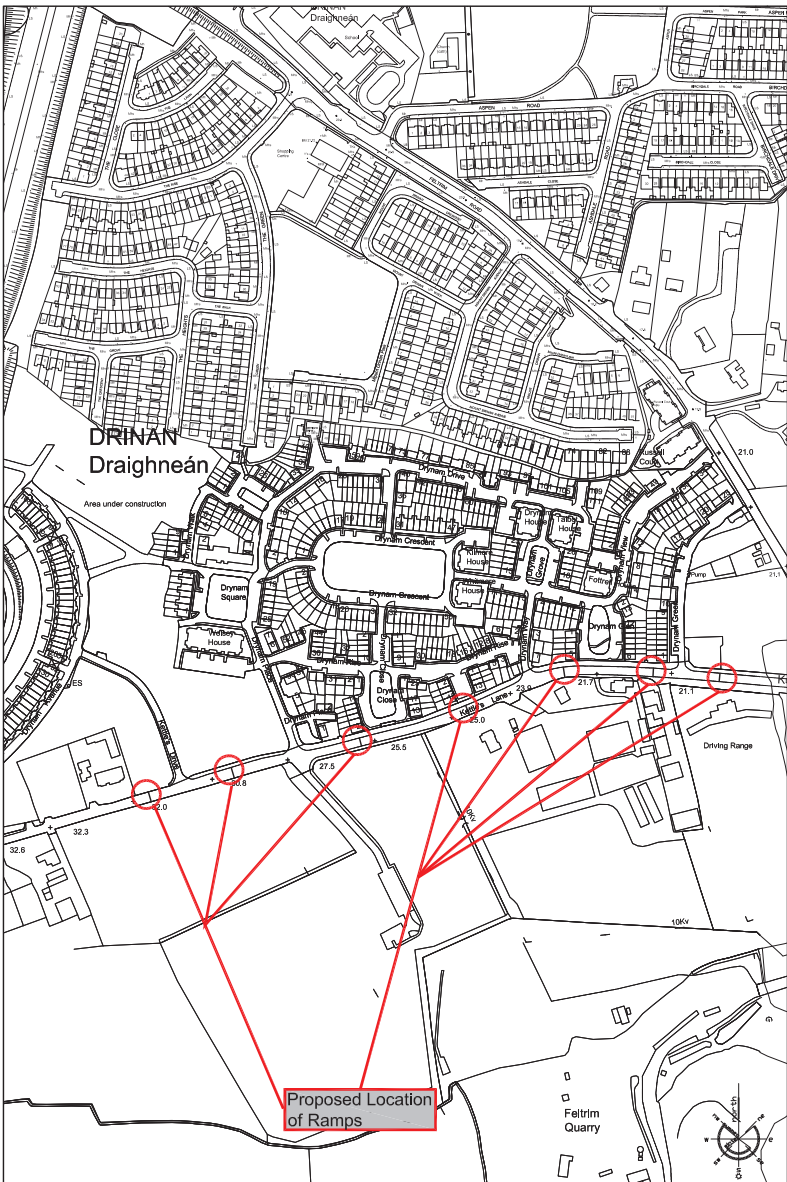

**Site Layout**  
Not to Scale

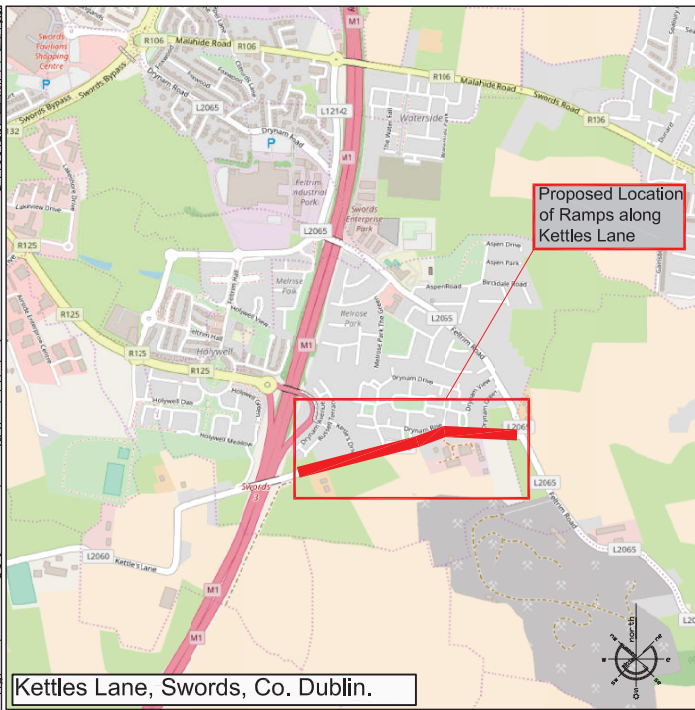

**Site Location Map**  
Not to Scale

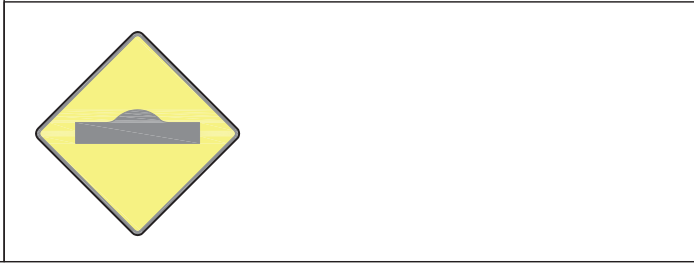
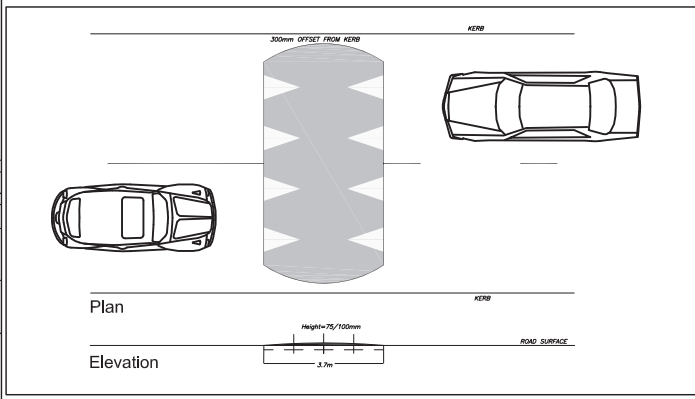

**COMHAIRLE CONTAE FINE GALL**  
**FINGAL COUNTY COUNCIL**  
**ROAD TRAFFIC ACTS 1993 – 2015**  
**PUBLIC TRANSPORT REGULATION ACT, 2009**  
**TRAFFIC CALMING SCHEME**  
**Kettles Lane, Swords**

Fingal County Council in exercise of the powers conferred on it under Section 38 of the Road Traffic Act, 1994 and Section 46 of the Public Transport Regulation Act, 2009 hereby gives notice that it has prepared a Scheme for the provision of traffic calming measures at the following location:

- Kettles Lane, Swords

The scheme provides for traffic calming ramps, appropriate road signage and markings where necessary.

Plans and particulars of the Scheme as shown on Drawing Number 2018-PD-TC-011, are available for inspection from Thursday 28<sup>th</sup> June to Thursday 16<sup>th</sup> August 2018 as follows:-

Location	Day	Opening Hours
Fingal County Council, County Hall, Main Street, Swords, Co. Dublin.	Monday – Friday	9:00 am – 5:00 pm (4.30 p.m. Friday)
Malahide Library, The Mall, Malahide, Co. Dublin.	Opening Hours	Mon - Thurs: 9:45am – 8:00pm Fri and Sat: 9:45am – 1:00pm and 1:45pm – 5:00pm Bank holiday weekends: Closed Saturday and Monday Sunday: Closed
Portmarnock Sports & Leisure Club, Blackwood Lane, Portmarnock, Co. Dublin.	Opening Hours	Centre Opening Hours

The proposed Scheme is also available to view on Fingal County Council's website: <https://consult.fingal.ie/>

Representations in relation to the proposed Scheme may be made in writing to the Road Authority, as follows: Administrative Officer, Howth Malahide Operations, Fingal County Council, Grove Road, Blanchardstown, Dublin 15 or email [howmaloparea@fingal.ie](mailto:howmaloparea@fingal.ie) to be received no later than 4.30 pm on Thursday 16th August 2018.

**Administrative Officer**  
**Howth Malahide Operations**

**Dated: Thursday 28<sup>th</sup> June 2018.**

All comments, including the names of those making comments, submitted to the Council in regard to this Traffic Calming Scheme will form part of the statutory reports to be presented to the monthly meeting of Fingal County Council.

Accordingly the statutory report will list the persons or bodies who made submissions or observations with respect to the proposed Traffic Calming Scheme in accordance with the regulations of the Road Traffic Act 1994.

The submissions will also be included in the minutes of that meeting and consequently will appear on the Council's Website. By making a submission the name of individual or bodies will appear on the statutory report and minutes of the meeting.

© Ordnance Survey Ireland. All Rights Reserved. Licence number 2017/24/CCMAIFingalCountyCouncil

**Fingal County Council**  
**Operations Department**

**Traffic Section**

**Traffic Management**  
**Scheme 2018**

**PUBLIC DISPLAY**  
**PROPOSED TRAFFIC CALMING SCHEME**  
**- KETTLES LANE, SWORDS, CO. DUBLIN.**

Comhairle Contae Fhine Gall  
Fingal County Council

Roinn na nOibríochtaí  
Operations Department



Traffic Section - Civic Offices, Grove Road, Blanchardstown, Dublin 15.  
☎ (01) 8905000 📧 roads@fingal.ie

Director of Services: David Storey Date:

Senior Engineer: Karen A Gallagher Scale: NTS

Senior Exec. Engineer: Andrew Nolan Drawn by: cof

Project Engineer: Silvana Di Ciaccio Revision:

Drawing Number: 2018-PD-TC-011



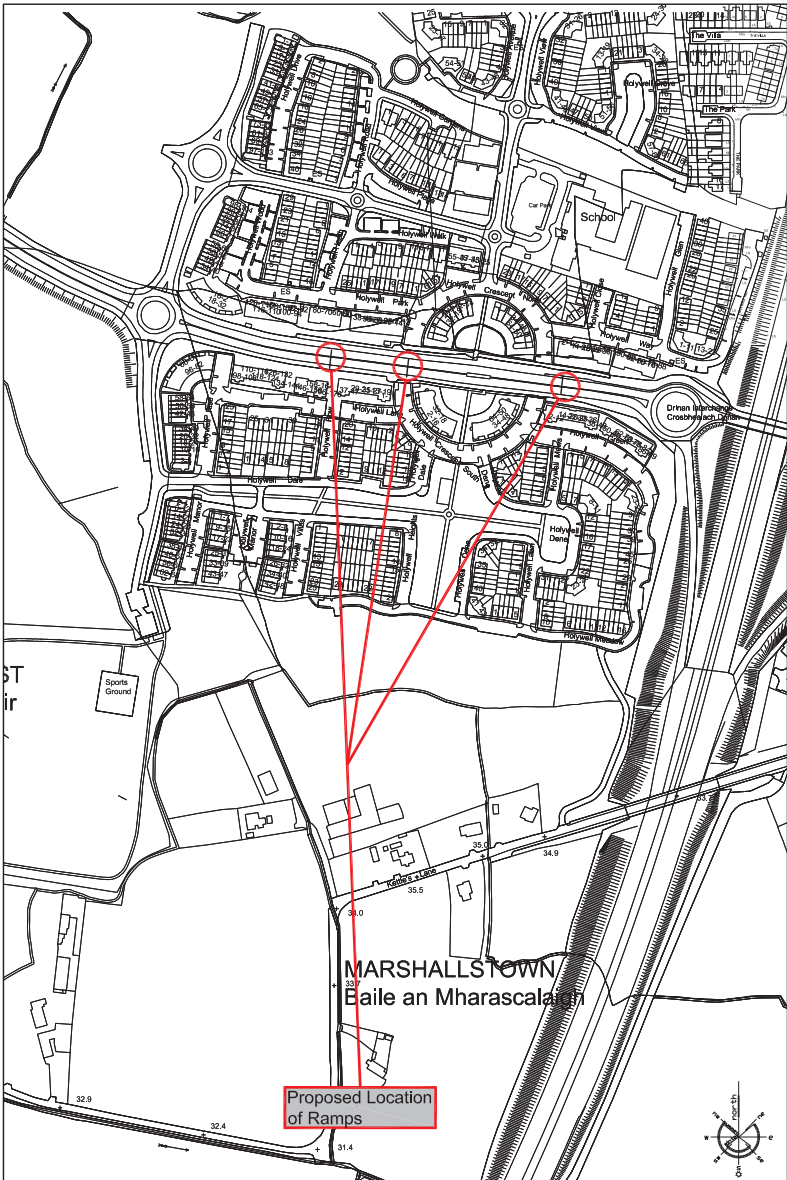

Site Layout  
Not to Scale

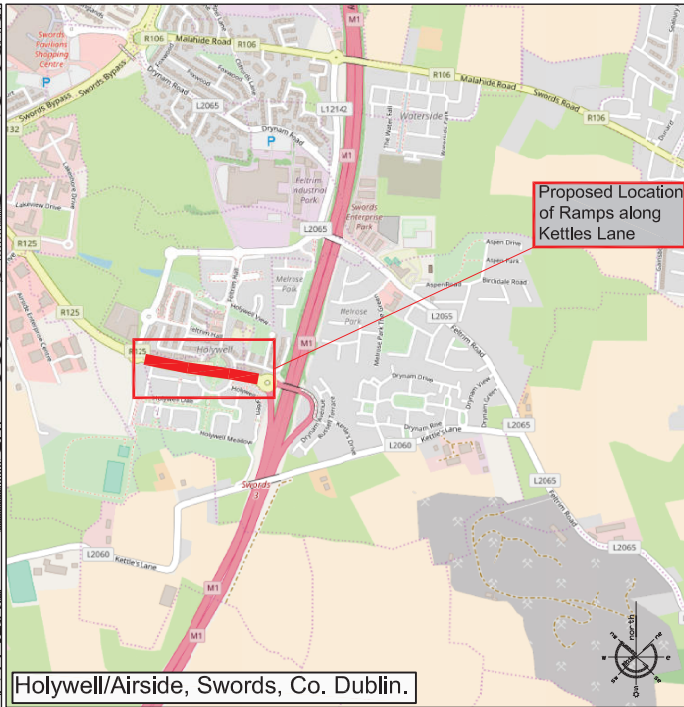

Holywell/Airside, Swords, Co. Dublin.  
Site Location Map  
Not to Scale

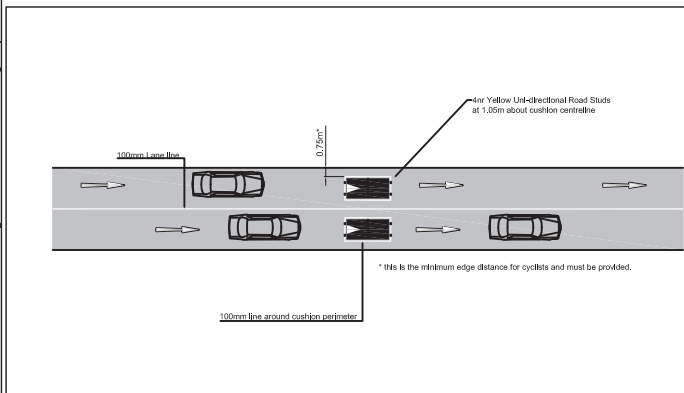

Traffic Calming Ramp  
Not to Scale

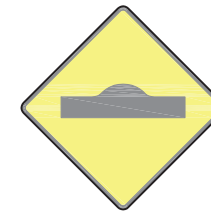

Road Signage  
Not to Scale

COMHAIRLE CONTAE FHINE GALL  
FINGAL COUNTY COUNCIL  
ROAD TRAFFIC ACTS 1993 – 2015  
PUBLIC TRANSPORT REGULATION ACT, 2009  
TRAFFIC CALMING SCHEME  
Holywell/Airside, Swords

Fingal County Council in exercise of the powers conferred on it under Section 36 of the Road Traffic Act, 1994 and Section 46 of the Public Transport Regulation Act, 2009 hereby gives notice that it has prepared a Scheme for the provision of traffic calming measures at the following location:

- Holywell/Airside, Swords

The scheme provides for traffic calming ramps, appropriate road signage and markings where necessary.

Plans and particulars of the Scheme as shown on Drawing Number 2018-PD-TC-012, are available for inspection from Thursday 28<sup>th</sup> June to Thursday 16<sup>th</sup> August 2018 as follows:-

Location	Day	Opening Hours
Fingal County Council, County Hall, Main Street, Swords, Co. Dublin.	Monday - Friday	9.00 am - 5.00 pm (4.30 p.m. Friday)
Malahide Library, The Mall, Malahide, Co. Dublin.	Opening Hours	Mon - Thurs: 9:45am - 8:00pm Fri and Sat: 9:45am - 1.00pm and 1:45pm - 5:00pm Bank holiday weekends: Closed Saturday and Monday Sunday: Closed
Portmarnock Sports & Leisure Club, Blackwood Lane, Portmarnock, Co. Dublin.	Opening Hours	Centre Opening Hours

The proposed Scheme is also available to view on Fingal County Council's website: <https://consult.fingal.ie/>

Representations in relation to the proposed Scheme may be made in writing to the Road Authority, as follows: Administrative Officer, Howth Malahide Operations, Fingal County Council, Grove Road, Blanchardstown, Dublin 15 or email [howmaloparea@fingal.ie](mailto:howmaloparea@fingal.ie) to be received no later than 4.30 pm on Thursday 16th August 2018.

Administrative Officer  
Howth Malahide Operations  
Dated: Thursday 28<sup>th</sup> June 2018.

All comments, including the names of those making comments, submitted to the Council in regard to this Traffic Calming Scheme will form part of the statutory report to be presented to the monthly meeting of Fingal County Council.

Accordingly the statutory report will list the persons or bodies who made submissions or observations with respect to the proposed Traffic Calming Scheme in accordance with the regulations of the Road Traffic Act 1994.

The submissions will also be included in the minutes of that meeting and consequently will appear on the Council's Website. By making a submission the name of individual or bodies will appear on the statutory report and minutes of the meeting.

© Ordnance Survey Ireland. All Rights Reserved. Licence number 2017/24/CCMAIFingalCountyCouncil

Fingal County Council  
Operations Department

Traffic Section

Traffic Management  
Scheme 2018

**PUBLIC DISPLAY**  
**PROPOSED TRAFFIC CALMING SCHEME**  
**- HOLYWELL/AIRSIDE, SWORDS, CO. DUBLIN.**

Comhairle Contae Fhine Gall  
Fingal County Council

Roinn na nOibríochtaí  
Operations Department



Traffic Section - Civic Offices, Grove Road, Blanchardstown, Dublin 15  
☎ (01) 8905000 📧 roads@fingal.ie

Director of Services: David Storey Date:

Senior Engineer: Karen A Gallagher Scale: NTS

Senior Exec. Engineer: Andrew Nolan Drawn by: caf

Project Engineer: Silvana Di Ciocelo Revision:

Drawing Number: 2018-PD-TC-012

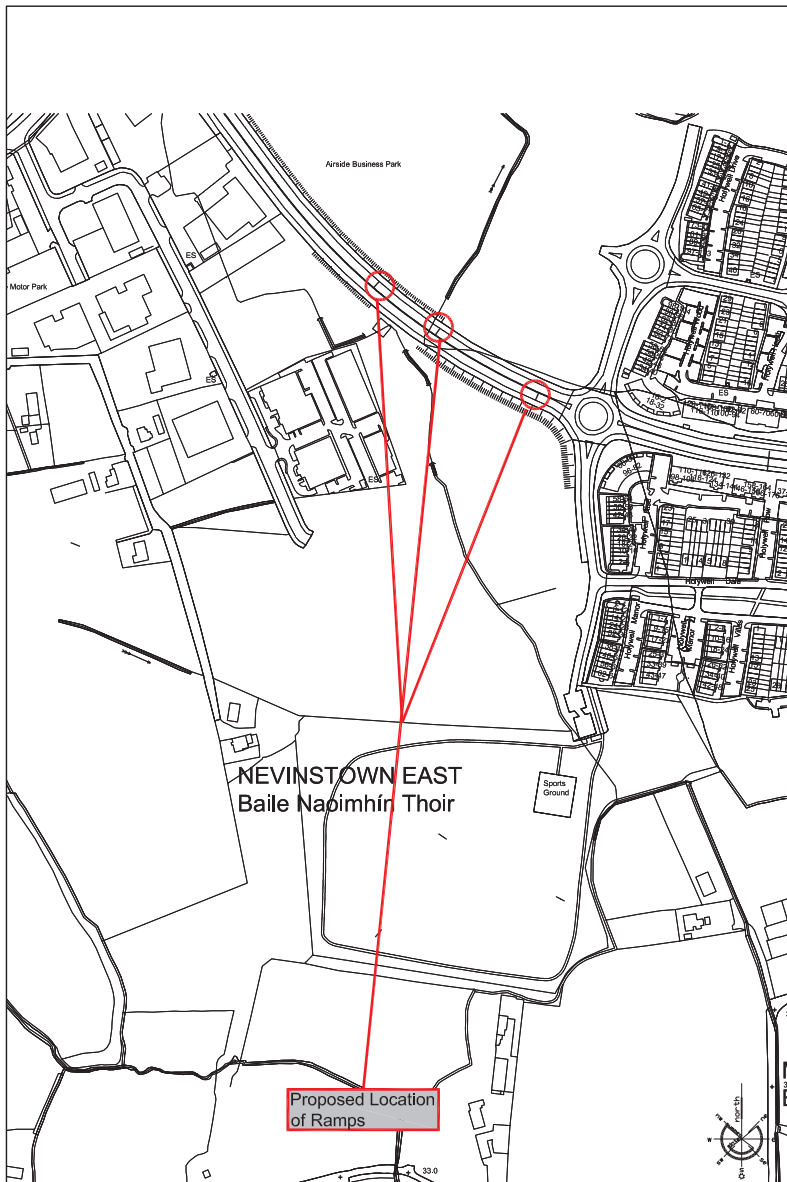

Site Layout  
Not to Scale

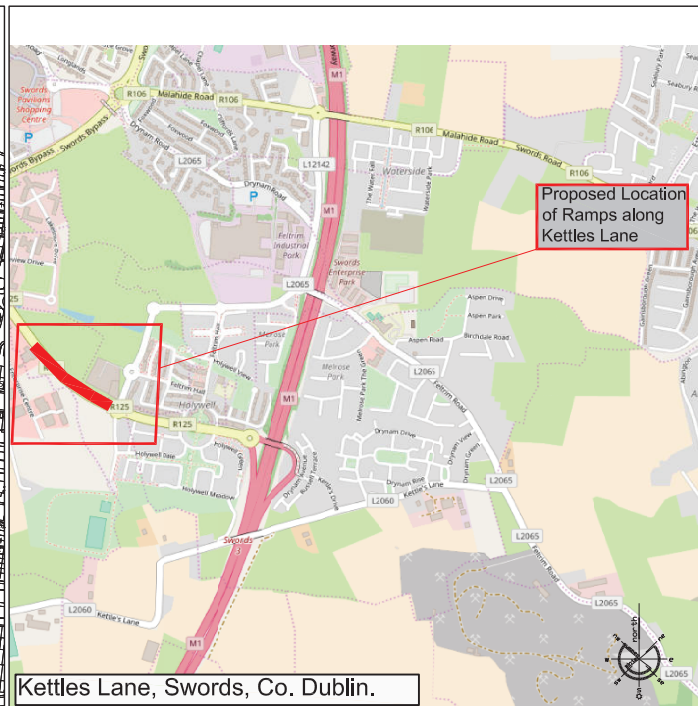

Kettles Lane, Swords, Co. Dublin.  
Site Location Map  
Not to Scale

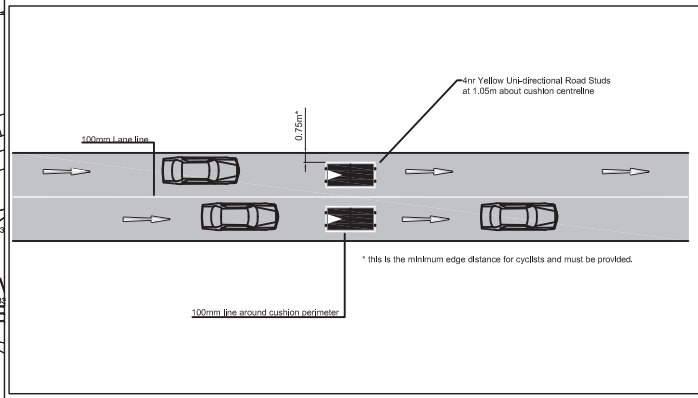

Traffic Calming Ramp  
Not to Scale

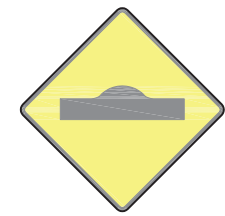

Road Signage  
Not to Scale

Airside, Swords  
Fingal County Council in exercise of the powers conferred on it under Section 38 of the Road Traffic Act, 1994 and Section 48 of the Public Transport Regulation Act 2009 hereby gives notice that it has prepared a Scheme for the provision of traffic calming measures at the following location:

- Airside, Swords
- The scheme provides for traffic calming ramps, appropriate road signage and markings where necessary.

Plans and particulars of the Scheme as shown on Drawing Number 2018-PD-TC-013, are available for inspection from Thursday 28<sup>th</sup> June to Thursday 16<sup>th</sup> August 2018 as follows:-

Location	Day	Opening Hours
Fingal County Council, County Hall, Main Street, Swords, Co. Dublin.	Monday - Friday	9:00 am - 5:00 pm (4.30 p.m. Friday)
Malahide Library, The Mall, Malahide, Co. Dublin.	Opening Hours	Mon - Thurs: 9:45am - 8:00pm Fri and Sat: 9:45am - 1:00pm and 1:45pm - 5:00pm Bank holiday weekends: Closed Saturday and Monday Sunday: Closed
Portmarnock Sports & Leisure Club, Blackwood Lane, Portmarnock, Co. Dublin.	Opening Hours	Centre Opening Hours

The proposed Scheme is also available to view on Fingal County Council's website: <https://consul.fingal.ie/>

Representations in relation to the proposed Scheme may be made in writing to the Road Authority, as follows: Administrative Officer, Howth Malahide Operations, Fingal County Council, Grove Road, Blanchardstown, Dublin 15 or email [howmaloparea@fingal.ie](mailto:howmaloparea@fingal.ie) to be received no later than 4.30 pm on Thursday 16th August 2018.

Administrative Officer  
Howth Malahide Operations

Dated: Thursday 28<sup>th</sup> June 2018.

All comments, including the names of those making comments, submitted to the Council in regard to this Traffic Calming Scheme will form part of the statutory report to be presented to the monthly meeting of Fingal County Council.

Accordingly the statutory report will list the persons or bodies who made submissions or observations with respect to the proposed Traffic Calming Scheme in accordance with the regulations of the Road Traffic Act 1994.

The submissions will also be included in the minutes of that meeting and consequently will appear on the Council's Website. By making a submission the name of individual or bodies will appear on the statutory report and minutes of the meeting.

**PUBLIC DISPLAY  
PROPOSED TRAFFIC CALMING SCHEME  
- AIRSIDE, SWORDS, CO. DUBLIN.**



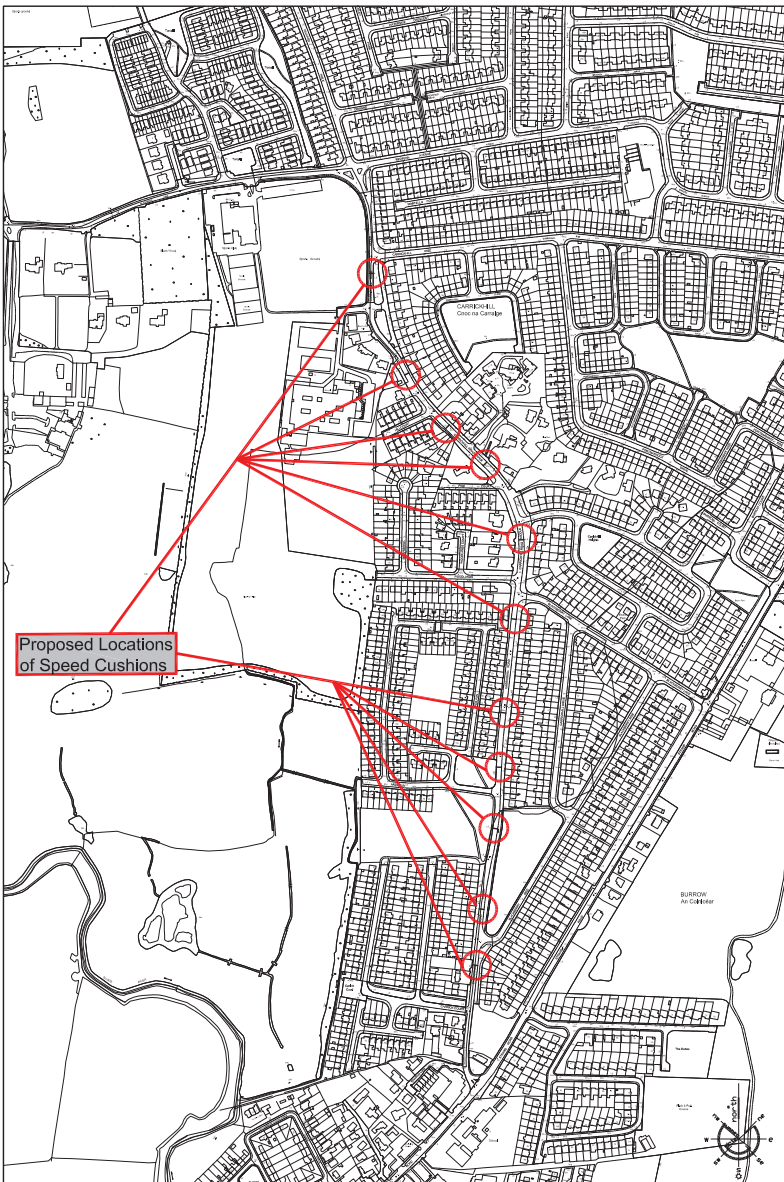

Site Layout  
Not to Scale

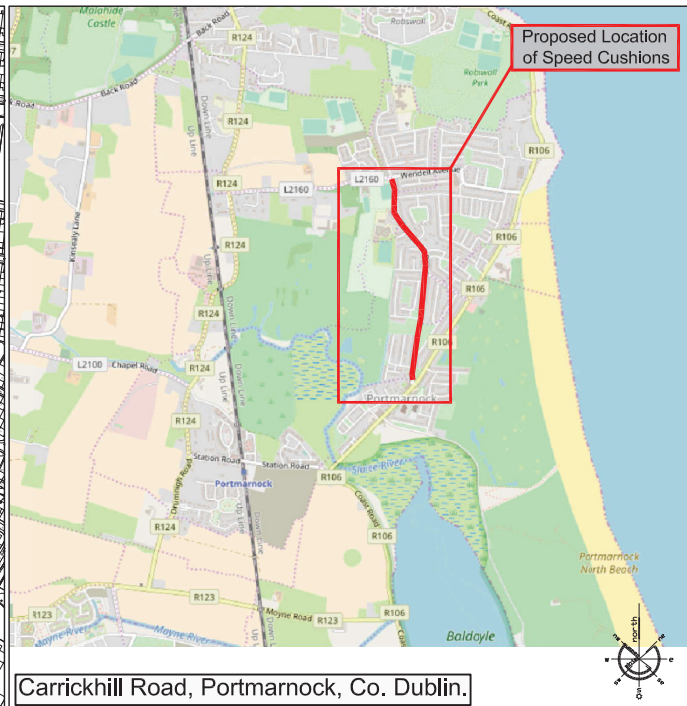

Carrickhill Road, Portmarnock, Co. Dublin.  
Site Location Map  
Not to Scale

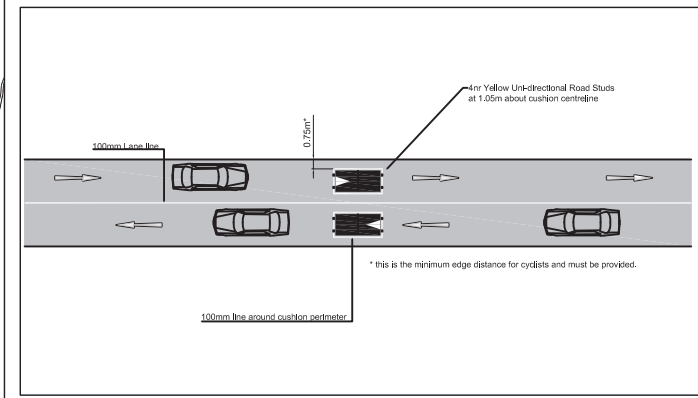

Traffic Calming Ramp  
Not to Scale

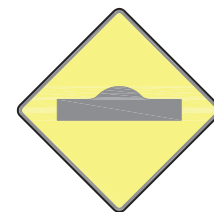

Road Signage  
Not to Scale

COMHAIRLE CONTAE FHINE GALL  
FINGAL COUNTY COUNCIL  
ROAD TRAFFIC ACTS 1993 – 2015  
PUBLIC TRANSPORT REGULATION ACT, 2009  
TRAFFIC CALMING SCHEME  
Carrickhill Road, Portmarnock

Fingal County Council in exercise of the powers conferred on it under Section 38 of the Road Traffic Act, 1994 and Section 46 of the Public Transport Regulation Act, 2009 hereby gives notice that it has prepared a Scheme for the provision of traffic calming measures at the following location:

- Carrickhill Road, Portmarnock

The scheme provides for traffic calming ramps, appropriate road signage and markings where necessary.

Plans and particulars of the Scheme as shown on Drawing Number 2018-PD-TC-043, are available for inspection from Thursday 28<sup>th</sup> June to Thursday 16<sup>th</sup> August 2018 as follows:-

Location	Day	Opening Hours
Fingal County Council, County Hall, Main Street, Swords, Co. Dublin.	Monday - Friday	9:00 am - 5:00 pm (4:30 p.m. Friday)
Malahide Library, The Mall, Malahide, Co. Dublin.	Opening Hours	Mon - Thurs: 9:45am - 8:00pm Fri and Sat: 9:45am - 1:00pm and 1:45pm - 5:00pm Bank holiday weekends: Closed Saturday and Monday Sunday: Closed
Portmarnock Sports & Leisure Club, Blackwood Lane, Portmarnock, Co. Dublin.	Opening Hours	Centre Opening Hours

The proposed Scheme is also available to view on Fingal County Council's website: <https://consult.fingal.ie/>

Representations in relation to the proposed Scheme may be made in writing to the Road Authority, as follows: Administrative Officer, Howth Malahide Operations, Fingal County Council, Grove Road, Blanchardstown, Dublin 15 or email [howmaloparea@fingal.ie](mailto:howmaloparea@fingal.ie) to be received no later than 4.30 pm on Thursday 16th August 2018.

Administrative Officer  
Howth Malahide Operations  
Dated: Thursday 28<sup>th</sup> June 2018.

All comments, including the names of those making comments, submitted to the Council in regard to this Traffic Calming Scheme will form part of the statutory report to be presented to the monthly meeting of Fingal County Council.

Accordingly the statutory report will list the persons or bodies who made submissions or observations with respect to the proposed Traffic Calming Scheme in accordance with the regulations of the Road Traffic Act 1994.

The submissions will also be included in the minutes of that meeting and consequently will appear on the Council's Website. By making a submission the name of individual or bodies will appear on the statutory report and minutes of the meeting.

© Ordnance Survey Ireland. All Rights Reserved. Licence number 2017/24/ECHAIF#FingalCountyCouncil

Fingal County Council  
Operations Department

Traffic Section

Traffic Management  
Scheme 2018

**PUBLIC DISPLAY**  
**PROPOSED TRAFFIC CALMING SCHEME**  
**- CARRICKHILL ROAD, PORTMARNOCK, CO. DUBLIN.**

Comhairle Contae Fhine Gall  
Fingal County Council

Roinn na nOibríochtaí  
Operations Department



Traffic Section - Civic Offices, Grove Road, Blanchardstown, Dublin 15  
☎ (01) 8905000 ✉ roads@fingal.ie

Director of Services: David Storey Date:

Senior Engineer: Karen A Gallagher Scale: NTS

Senior Exec. Engineer: Andrew Nolan Drawn by: cof

Project Engineer: Silvana Di Ciocelo Revision:

Drawing Number: 2018-PD-TC-014